

HV320 Series Frequency Inverter User Manual



Preface

Manual introduction

HV320 series drive mainly used to control and adjust the speed and torque of the three-phase asynchronous motor, can be used for textile, paper, wire drawing, machine tools, packaging, food, fan, water pumps and a variety of automatic production equipment drive.

This manual details the system composition, components, dimensions, technical data, as well as mechanical installation, electrical installation, commissioning and trial operation, fault handling, daily maintenance and maintenance, specifications and selection of selected parts, function code, fault code, etc.

content



Preface.....	1
Chapter 1 Safety Information and Precautions.....	2
1.1 Safety Precautions.....	2
1.2 Safety Precautions.....	6
Chapter 2 Product Information.....	9
2.1 Product model list.....	10
2.2 Nameplate and Model.....	14
Chapter 3 Introduction of the spare parts.....	16
3.1 Summary.....	16
Chapter 4 Technical Data.....	21
4.1 Electrical parameters.....	21
4.2 Technical Specifications.....	30
4.3 Brake assembly type selections guide.....	34
Chapter 5 Installation and Wiring.....	36
5.1 Mechanical installation.....	36
5.2 Electrical installation.....	38
5.3 Control terminal wiring instructions	43
Chapter 6 Operation and display application examples	53
6.1 Operation and display panel introduction.....	53
6.2 Function code to view,modify the method description	54
6.3 How the drive function code is organized	55
6.4 Review of the status parameters.....	56
6.5 Start-stop control of the drive	59
Chapter 7 Functional parameter table	69
7.1 Table of basic function parameters.....	69

7.2 Monitor parameter brief.....	103
Chapter 8 Parameter description	105
P0 group, the basic function group	105
First motor parameters of the P1 group	118
P2 group of vector control parameters	123
P3 group of input terminal	125
P4 group of input terminal	133
P5 sets of output terminals	148
P6 group start-stop control	154
P7 group keyboard and display	161
P8 group auxiliary functionl	166
P9 group failure and protection	177
PA group process control PID function	187
Pulum frequency, fixed length and count in Pb group	195
PC group multiparagraph instructions and simple PLC function	197
PE group user custom function code	203
PP group function code management	205
Chapter 9 E M C	228
EMC guide	228
Chapter 10 Maintenance and fault diagnosis	230
10.1 Daily maintenance and maintenance of the drive	230
10.2 Common faults and their handling methods	235
Appendix Modbus communication agreement	238



Chapter1 Safety Information and Precautions

1.1 Safety Precautions



1.1.1 Before Installation:

 Danger	<ul style="list-style-type: none">● Do not use the water-logged inverter, damaged inverter or inverter with missing parts. Otherwise, there may be risk of injury.● Use the motor with Class B or above insulation. Otherwise, there may be risk of electric shock.
 Caution	<ul style="list-style-type: none">● Carefully handled when loading, otherwise it may damage the inverter.● Please don't use the damaged driver or inverter with missing parts, there may be risk of injury.● Do not touch the electronic parts and components; otherwise it will cause static electricity.

1.1.2 During Installation:



 Danger	<ul style="list-style-type: none">● Install the inverter on incombustible surface such as metal, and keep away from flammable substances. Otherwise it may cause fire.● Do not loose the set screw of the equipment, especially the screws marked in RED.
 Caution	<ul style="list-style-type: none">● Do not drop the cable residual or screw in the inverter. Otherwise it may damage the inverter.● Please install the driver in the place where there is no direct sunlight or less vibratory.● When more than two inverters are to be installed in one cabinet, due attention should be paid to the installation locations (refer to Chapter 3 Mechanical and Electrical Installation) to ensure the heat sinking effect.

1.1.3 During Wiring:



 Danger	<ul style="list-style-type: none">● Operation should be performed by the professional engineering technician. Otherwise there will be danger of electric shock!● There should be circuit breaker between the inverter and power supply. Otherwise, there may cause fire!● Make sure the power is disconnected prior to the connection. Otherwise there will be danger of electric shock!● The ground terminal should be earthed reliably. Otherwise there may be danger of electric shock.
 Caution	<ul style="list-style-type: none">● Never connect AC power to output U, V, W terminals. Please note the remark of the wiring terminals, connect them correctly. Otherwise it will cause inverter be damaged.● Ensure the wiring circuit can meet the requirement of EMC and the area safety

	<p>standard. Please follow the instructions in the manual before wiring. Otherwise may cause injury or electric shock.</p> <ul style="list-style-type: none"> ● Never connect the braking resistor between DC Bus (+), (-) terminals. Otherwise may cause fire. ● Encoder must be used together with shielded wire, and ensure the single terminal of the shielded lay is connected with ground well.
--	---



1.1.4 Before Power-on:

 Danger	<ul style="list-style-type: none"> ● Please confirm whether the power voltage class is consistent with the rated voltage of the inverter and whether the I/O cable connecting positions are correct, and check whether the external circuit is short circuited and whether the connecting line is firm. Otherwise it may damage the inverter. The cover must be well closed prior to the inverter power-on. Otherwise electric shock may be caused. ● The inverter is free from dielectric test because this test is performed prior to the delivery. Otherwise accident may occur.
 Caution	<ul style="list-style-type: none"> ● The cover must be well closed prior to the inverter power-on. Otherwise electric shock may be caused! ● Whether all the external fittings are connected correctly in accordance with the circuit provided in this manual. Otherwise accident may occur!

1.1.5 After Power-on:

 Danger	<ul style="list-style-type: none"> ● Do not open the cover of the inverter upon power-on. Otherwise there will be danger of electric shock! ● Do not touch the inverter and its surrounding circuit with wet hand. Otherwise there will be danger of electric shock! ● Do not touch the inverter terminals (including control terminal). Otherwise there will be danger of electric shock! ● At power-on, the inverter will perform the security check of the external heavy-current circuit automatically. Thus, at the moment please do not touch the terminals U, V and W, or the terminals of motor, otherwise there will be danger of electric shock.
 Caution	<ul style="list-style-type: none"> ● If parameter identification is required, due attention should be paid to the danger of injury arising from the rotating motor. Otherwise accident may occur! ● Do not change the factory settings at will. Otherwise it may damage the equipment!

1.1.6 During Operation:

 Danger	<ul style="list-style-type: none">● Do not touch the fan or discharge resistor to sense the temperature. Otherwise, you may get burnt!● Detection of signals during the operation should only be conducted by qualified technician. Otherwise, personal injury or equipment damage may be caused!
 Caution	<ul style="list-style-type: none">● During the operation of the inverter, keep items from falling into the equipment. Otherwise, it may damage the equipment!● Do not start and shut down the inverter by connecting and disconnecting the contactor. Otherwise, it may damage the equipment!

1.1.7 During Maintain:

 Danger	<ul style="list-style-type: none">● Do not repair and maintain the equipment with power connection. Otherwise there will be danger of electric shock!● Be sure to conduct repair and maintenance after the charge LED indicator of the inverter is OFF. Otherwise, the residual charge on the capacitor may cause personal injury!● The inverter should be repaired and maintained only by the qualified person who has received professional training. Otherwise, it may cause personal injury or equipment damage!● Carry out parameter setting after replacing the inverter, all the plug-ins must be plug and play when power outage.
---	--

1.2 Safety precautions

1.2.1 Motor insulation inspection

Before the first use and during the regular inspection, the motor insulation inspection should be done to prevent the damage to the drive due to the insulation failure of the motor winding. During the insulation inspection, the motor connection must be separated from the driver. It is recommended to use the 500V voltage megohm meter, and ensure that the measured insulation resistance is not less than 200M Ω .

1.2.2 Thermal protection of motor

In the mismatch between the motor and the rated capacity of the driver, especially when the rated power of the driver is greater than the rated power of the motor, we must adjust the value of the motor protection parameters in the drive or install a thermal relay in front of the motor to protect the motor.

1.2.3 Operation frequency above

This drive can provide an output frequency of up to 0 Hz to 500 Hz. If the customer needs to operate above 50Hz, please consider the endurance of the mechanical device.

1.2.4 Vibration of the mechanical devices

At some output frequencies, the drive may encounter the mechanical resonance point of the load device, which is avoided by setting the jump frequency parameters within the drive.

1.2.5 About the motor heating and noise

Because the output voltage of the driver is PWM wave, with a certain harmonic, so the temperature rise, noise and vibration of the motor will be slightly increased compared with the power frequency operation.

1.1.1 There of voltage sensitive devices or capacitance on the output side

Drive output is PWM wave, if the output side is installed with a capacity to improve the power factor of the capacitance or lightning protection varistor, easy to cause the drive instantaneous overcurrent or even damage the drive, do not use.

1.2.6 Switching devices such as contactors for drive input and output terminals

If a contactor is installed between the power supply and the drive input, this contactor is not allowed to control the start and stop of the drive. It is necessary to use the contactor to control the drive to start and stop, and the interval should not be less than one hour.

Frequent charge and discharge can easily reduce the service life of the capacitor in the drive.

If there are switch devices such as contactor installed between the output end and themotor, ensure that the driver is operated on and off when there is no output, otherwise it will easily cause damage to the module in the drive.

1.2.7 Use other than the rated voltage value

It is not suitable to use this series of drives outside the allowable operating voltage range specified in the manual, causing damage to the devices in the drive. To use in this case, the corresponding boost or lowering device should be added before input to the driver.

1.2.8 Three-phase input is changed to two-phase input

Do not change the three-phase drive to two-phase use, otherwise it may cause the drive failure or damage

1.2.9 Lightning impact protection

This series of drives is equipped with lightning overcurrent protection device, which has a certain self-protection ability for the induction of lightning, but for frequent lightning generation, customers should also install lightning protection device at the front end of the drive.

Elevation and derating use

In the altitude of more than 1000m, due to the thin air, it is necessary to reduce the cooling effect of the drive. Please consult our company for technical consultation on this situation.

Some special usage

If the customers need to use the methods other than the suggested wiring diagram provided in this manual, such as the common DC bus bar, please consult with us.

Note when the drive is scrapped

An explosion may occur in the electrolytic capacitor of the main circuit and on the printed board. Plastic parts will produce toxic gas when burned. Please treat it as industrial waste.

About the adaptation motor

The standard adaptation motor is a quadrupole cage induction motor. If the motor is not mentioned above, please select the drive according to the rated current of the motor implement. The cooling fan of the non-frequency conversion motor is coaxial connection with the rotor shaft. When the speed decreases, the fan cooling effect is reduced, so the motor is out Current overheating occasions should be equipped with a strong exhaust fan or replaced with a frequency conversion motor. The driver has built-in adaptive motor standard parameters. It is necessary to identify the motor parameters or modify the default value to meet the actual value as much as possible, otherwise the operation effect and protection performance will be affected.

Because the short circuit inside the cable or the motor will cause the driver alarm or even blast the machine, so please first conduct the insulation short circuit test on the initial installed motor and cable, and this test should be conducted frequently in the daily maintenance. Note that when doing this test, always disconnect the drive from the tested part.

Chapter 2 Product Information

Product positioning and characteristics

The HV320-Series Drive is A general-purpose high-performance magnetic flux vector drive that is mainly used to control and adjust the speed and torque of A three-phase AC asynchronous motor. Using high-performance vector control technology, low speed and high torque output, with good dynamic characteristics, super overload capacity, with user programmable function and background software monitoring, communication bus function, support a variety of encoder types, rich and powerful combination function, stable performance. Can be used in textile, paper making, wire drawing, machine tool, packaging, food, fan, water pump and a variety of automatic production equipment drive.

Characteristic

The HV320-series driver adopts the European-type modular design scheme. Unique structural design. Make everything easy in the process of use!

一: **Easy to install**

- (1) Key hole design
- (2) Guide rail installation
- (3) Spring-snap control terminal

二: **Convenient application** (1) Change the control unit arbitrarily (2) Can add multifunctional terminal card, PG card and bus box at will (3) Add software

application macro debugging is simple (4) Parameter copy function

三: **Simple after-sales repair** (1) It can be replaced damaged unit, such as OP panel, CM control unit, PM power unit, PG expansion unit, fan; (2) When the PM is damaged, there is no need to replace the CM, which is convenient to replace without adjusting the parameters and control lines, greatly saving the after-sales cost and labor cost.

Figure 2-1 Product appearance diagram

2.1 Product model list



Table 2-1 Corresponding relation

Volume	Product model (three-phase 380V)	Three-pase220V	Single-pase220V
A1	HV320-R75G3 HV320-1R5G3 HV320-2R2G3 HV320-004G3	HV320-R40G2 HV320-R75G2 HV320-1R5G2 HV320-2R2G2	HV320-R40G1 HV320-R75G1 HV320-1R5G1 HV320-2R2G1
A2	HV320-5R5G3 HV320-7R5G3	HV320-004G2	HV320-004G1
A3	HV320-011G3 HV320-015G3	HV320-5R5G2 HV320-7R5G2	
A4	HV320-018G3 HV320-022G3	HV320-011G2	

A5	HV320-030G3	HV320-015G2	
A6	HV320-037G3 HV320-045G3	HV320-018G2 HV320-022G2	
A7	HV320-055G3 HV320-075G3	HV320-030G2 HV320-037G2	
A8	HV320-090G3 HV320-110G3	HV320-045G2	
A9	HV320-132G3	HV320-055G2	

Model number and technical parameters

Volume	Drive model	Output capacity (KVA)	Input current (A)	Output current (A)	Suitable Motor (KW)
	G1: Single Phase AC220~240V, 50Hz/60Hz				
A1	HV320-R40G1	1.4	5.4	2.3	0.4
	HV320-R75G1	2.2	8.2	4	0.75
	HV320-1R5G1	3.7	14	7	1.5
	HV320-2R2G1	6.0	23	9.6	2.2
A2	HV320-004G1	10.0	32	13	4.0

volume	Drive model	Output capacity (KVA)	Input current (A)	Output current (A)	Suitable Motor (KW)
	G2: Three Phase AC220~240V, 50Hz/60Hz				
A1	HV320-R40G2	1.1	2.4	2.1	0.4
	HV320-R75G2	2.1	4.6	3.8	0.75
	HV320-1R5G2	4.2	9	7.2	1.5
	HV320-2R2G2	5.3	11.4	9	2.2
A2	HV320-004G2	7.7	16.7	13	4.0
A3	HV320-5R5G2	14.8	32	25	5.5
	HV320-7R5G2	18.9	41	32	7.5
A4	HV320-011G2	21	4	45	11
A5	HV320-015G2	27	57	60	15
A6	HV320-018G2	31.6	69	75	18.5
	HV320-022G2	42	90	91	22
A7	HV320-030G2	49	106	112	30
	HV320-037G2	64	141	150	37
A8	HV320-045G2	75	164	176	45
A9	HV320-055G2	90	201	210	55

volume	Drive model	Output capacity (KVA)	Input current (A)	Output current (A)	Suitable Motor (KW)
	G3: Three Phase AC380V, 50Hz/60Hz				
A1	HV320-R75G3	1.5	3.4	2.1	0.75
	HV320-1R5G3	3.0	5.0	3.8	1.5
	HV320-2R2G3	4.0	5.8	5.1	2.2
	HV320-004G3	5.9	10.5	9	4.0
A2	HV320-5R5G3	8.9	14.6	13	5.5
	HV320-7R5G3	11	20.5	17	7.5
A3	HV320-011G3	17	26	25	11
	HV320-015G3	21	35	32	15
A4	HV320-018G3	24	38.5	37	18.5
	HV320-022G3	30	46.5	45	22
A5	HV320-030G3	40	62	60	30
A6	HV320-037G3	57	76	75	37
	HV320-045G3	69	92	91	45
A7	HV320-055G3	85	113	112	55
	HV320-075G3	114	157	150	75
A8	HV320-090G3	134	180	176	90
	HV320-110G3	160	214	210	110
A9	HV320-132G3	192	256	253	132

2.2 Nameplate and Model

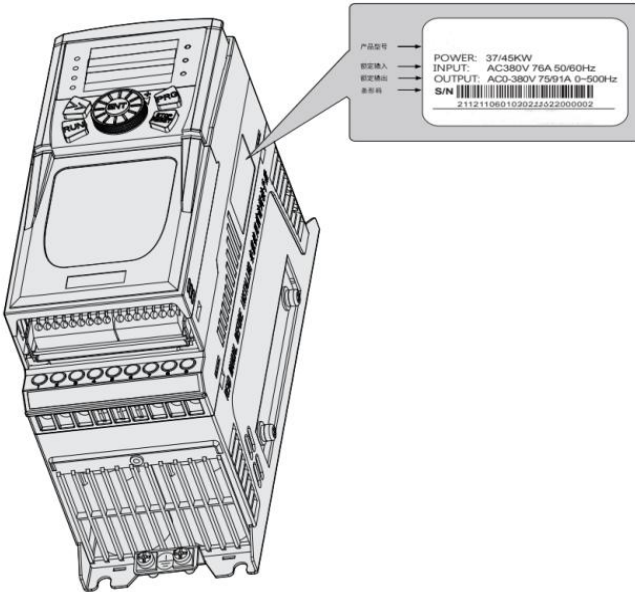

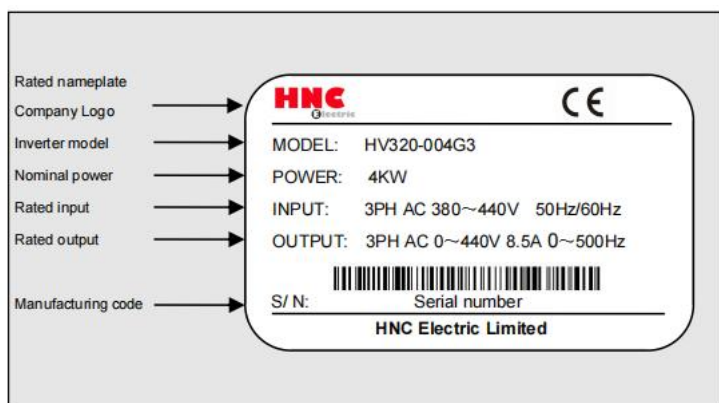
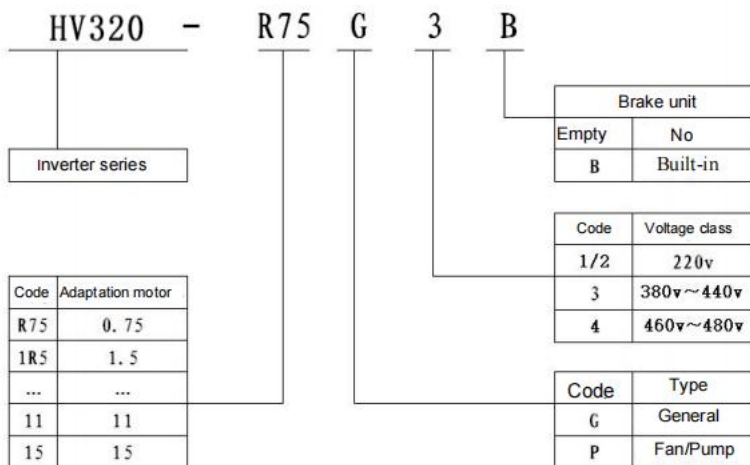

Figure 2-2 nameplate and product naming

Chapter 3 Introduction of the spare parts

3.1 Summary

The HV320-series drives are composed of many different functional modules, and the main modules are as follows:

PM Power module

CM control module

OP operation display module

EM expansion module (optional)

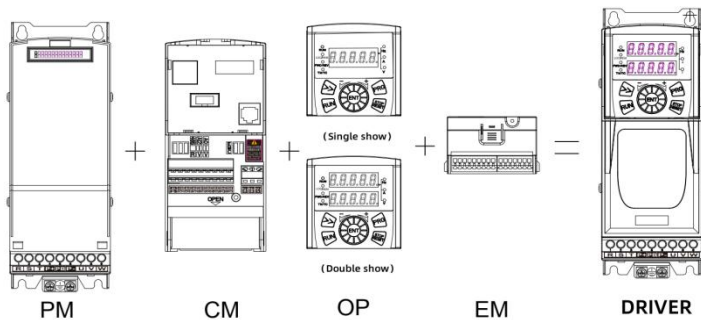

Figure 2-3 The modular composition diagram of the product

Power module The power module ranges from 0.75 kW to 630 kW. The high-reliability IGBT and isolation drive technology are adopted. The scientific heat dissipation design ensures the safe operation at 50°C ambient temperature.

Control module Support synchronous or asynchronous V / F mode, open loop vector mode, closed loop vector mode and other ways to control and protect the power module and the driven load motor. Standard configuration of multi-channel AO, IO and RS485 communication at the same time, reserved can be expanded interface, to facilitate customers to deal with various applications.

Operation display module (optional) Used for drive debugging, operation monitoring, and parameter setting. Standard configuration of single LED operation panel, and support for extended external introduction (OPT 1 or OPT 2 type tray), and optional dual LED operation panel and LCD operation panel.

Expansion Module (optional) Expand the interface connection with the control module, can realize a variety of functional interface expansion, IO expansion, PG expansion, communication expansion, etc.

Description of functional version			
Numb	Part name	Imprint	Remark
1	HV320 card	HV320-IO-01	IO Functional terminal extension
2		HV320-485-01	Quarantine of the 485 communication extension
3		HV320-CAN-01	CAN Bus extension
4		HV320-DP-01	PROFIBUS DP Highway
5		HV320-PG-01	Open-circuit collector encoder PG
6		HV320-PG-02	Differential encoder PG
7		HV320-PG-03	Spinning encoder PG
8		more cards reserved...	

Installation drawing of appearance and dimensions

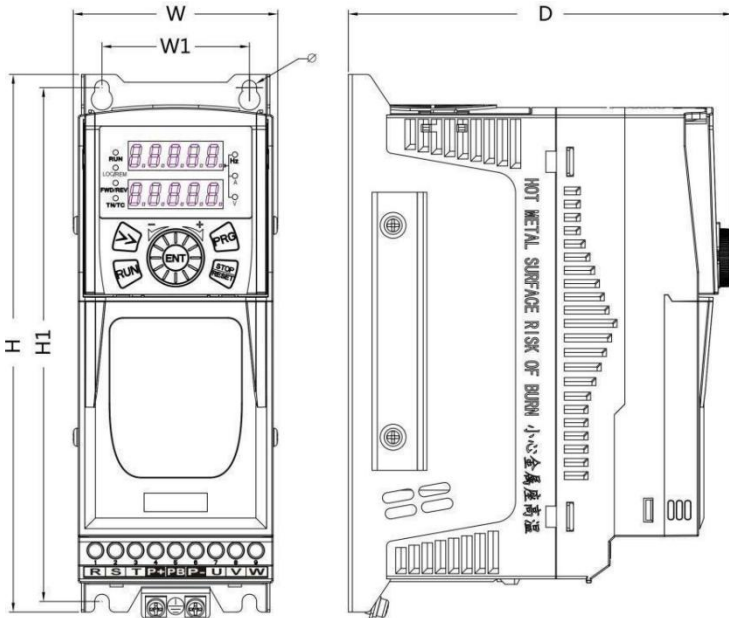

A1~ A2

unit: mm

Numb	Installation size		Installation size			Installation aperture
	W1	H1	W	H	D	Φ
A1	56	194	77.7	203	145.8	5.5
A2	68	218.5	93	235	145	5.0

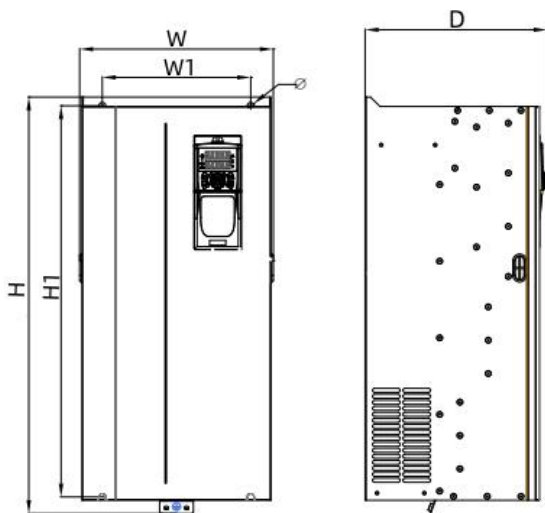

A3~A9

Numb	Installation size		Installation size			Installation aperture
	W1	H1	W	H	D	Φ
A3	100	264.5	142	282.5	187	7.0
A4	120	288.5	150	305	202	7.0
A5	120	313.5	180	330	208.5	6.5
A6	160	366.5	268	380.5	246	6.5
A7	220	484	307	500	255	6.5
A8	220	612	307	650	270	10
A9	220	639	317	661	320	10

OPT1~OPT2

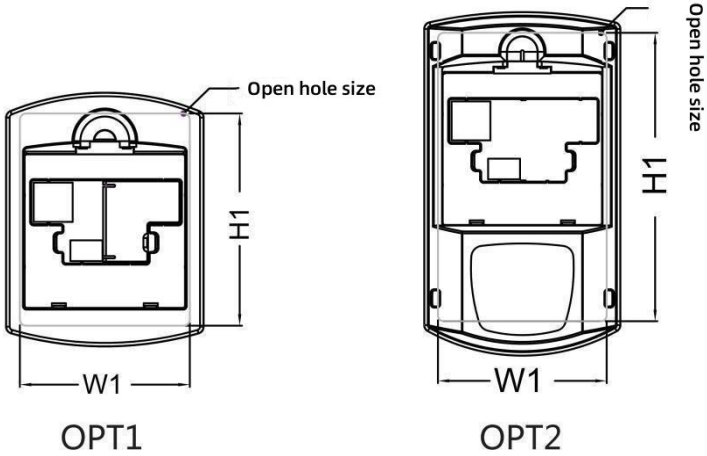

Unit: mm

Numb	Install the opening size	
	W1	H1
OPT1	73.5	91.5
OPT2	73.5	125.5

Chapter 4 Technical Data

4.1 Electrical parameters

Single-phase 220V ~ 240V

Project		Specifications				
Power (kW)		0.4	0.75	1.5	2.2	4.0
Volume		A1			A2	
out put	Adapt motor capacity (kW)	0.4	0.75	1.5	2.2	4.0
	Rated output current (A)	2.3	4	7	9.6	13.0
	Output voltage (V)	Single items from 0 to input voltage				
	Maximum output frequency	500HZ(Change is available by parameters)				
	Carrier frequency	0.5KHZ~16.0KHZ				
	Overload capacity	150%rated current 60S				
In put	Rated input current (A)	5.4	8.2	14	23	32
	Rated voltage, rated frequency	AC: 1-phase 220V~240V, 50 / 60 HZ				
	Voltage allowable fluctuation range	-15%~10%, the actual allowable range: AC 187V~264V				
	Frequency is allowed to fluctuation range	-5%~5%, the actual allowable range: 47.5HZ ~ 63 HZ				
	Power capacity (KVA)	1.4	2.2	3.7	6.0	10
Levels of protection		IP20 (open type, IP protection rating for IEC products) Type1 (enclosed type, Type1 protection class for UL products)				

Three-phase 220V ~ 240V

Project		Specifications				
Power (kW)		0.4	0.75	1.5	2.2	4.0
Volume		A1			A2	
Output	Adapt motor capacity (kW)	0.4	0.75	1.5	2.2	4.0
	Rated output current (A)	2.1	3.8	7.2	9.0	13.0
	Output voltage (V)	Single items from 0 to input voltage				
	Maximum output frequency	500HZ(Change is available by parameters)				
	Carrier frequency	0.5KHZ~16.0KHZ				
	Overload capacity	150%rated current 60S				
Input	Rated input current (A)	2.4	4.6	9	11.4	16.7
	Rated voltage, rated frequency	AC: 3-phase 220V~240V, 50 / 60 HZ				
	Voltage allowable fluctuation range	-15%~10%, the actual allowable range: AC 187V~264V				
	Frequency is allowed to fluctuation range	-5%~5%, the actual allowable range: 47.5HZ ~ 63 HZ				
	Power capacity (KVA)	1.1	2.1	4.2	5.3	7.7
Levels of protection		IP20 (open type, IP protection rating for IEC products) Type1 (enclosed type, Type1 protection class for UL products)				

Project		Specifications		
Power (kW)		5.5	7.5	11
Volume		A3		A4
Output	Adapt motor capacity (kW)	5.5	7.5	11
	Rated output current (A)	25	32	45
	Output voltage (V)	Three items from 0 to input voltage		
	Maximum output frequency	500 HZ (parameter parameter parameters)		
	Carrier frequency	0.5HZ~16.0HZ		
	Overload capacity	150%rated current 60S		
Rated input current (A)		32	41	59
Input	Rated voltage, rated frequency	AC: 3-phase 220V~240V, 50 / 60 HZ		
	Voltage allowable fluctuation range	-15%~10%, the actual allowable range: AC 187V~264V		
	Frequency is allowed to fluctuation range	-5%~5%, the actual allowable range: 47.5HZ ~ 63 HZ		
	Power capacity (KVA)	14.8	18.9	27
Levels of protection		IP20 (open type, IP protection rating for IEC products) Type1 (enclosed type, Type1 protection class for UL products)		

Project		Specifications		
Power (kW)		15	18	22
Volume		A5	A6	
Output	Adapt motor capacity (kW)	15	18	22
	Rated output current (A)	60	75	91
	Output voltage (V)	Three items from 0 to input voltage		
	Maximum output frequency	500 HZ (parameter parameter parameters)		
	Carrier frequency	0.5HZ~16.0HZ		
	Overload capacity	150%rated current 60S		
Input	Rated input current (A)	57	69	90
	Rated voltage, rated frequency	AC: 3-phase 220V~240V, 50 / 60 HZ		
	Voltage allowable fluctuation range	-15%~10%, the actual allowable range: AC 187V~264V		
	Frequency is allowed to fluctuation range	-5%~5%, the actual allowable range: 47.5HZ ~ 63 HZ		
	Power capacity (KVA)	21/27	31.6	42
Levels of protection		IP20 (open type, IP protection rating for IEC products) Type1 (enclosed type, Type1 protection class for UL products)		

Project		Specifications			
Power (KW)		30	37	45	55
Volume		A7		A8	A9
Out	Adapted motor capacity (KW)	30	37	45	55
	Rated output current (A)	112	150	176	210
put	Output voltage (V)	Three-phase 0 to input voltage			
	Maximum output frequency	500 HZ (parameter parameter parameters)			
	Carrier frequency	0.5HZ~16.0HZ			
	Overload capacity	150% rated current 60S			
In put	Rated input current (A)	106	141	164	201
	Rated voltage, rated frequency	AC: 3-phase 220V~240V, 50 / 60 HZ			
	Voltage allowable fluctuation range	-15%~10%, the actual allowable range: AC 187V~264V			
	Frequency is allowed to fluctuation range	-5%~5%, the actual allowable range: 47.5HZ ~ 63 HZ			
	Power Supply Capacity (KVA)	49	64	75	90
Levels of protection		IP20 (open type, IP, protection grade for IEC products) Type1 (enclosed type, Type1 protection class for UL products)			

Three-phase 380V ~ 480V

Table 4-1 Electrical Parameters (3-phase 380V~480V)

Project		Specifications				
Power (kW)		0.7	1.5	2.2	4.0	5.5
Volume		A1			A2	
Output	Adapt motor capacity (KW)	0.7	1.5	2.2	4.0	5.5
	Rated output current (A)	2.1	3.8	5.1	9.0	13.0
	Output voltage (V)	Three items from 0 to input voltage				
	Maximum output frequency	500HZ(Change is available by parameters)				
	Carrier frequency	0.5HZ~16.0HZ				
	Overload capacity	150%rated current 60S				
Input	Rated input current (A)	3.4	5.0	5.8	10.5	14.6
	Rated voltage, rated frequency	AC: 3-phase 380V~480V, 50 / 60 HZ				
	Voltage allowable fluctuation range	-15%~10%, the actual allowable range: AC 320V~528V				
	Frequency is allowed to fluctuation range	-5%~5%, the actual allowable range: 47.5HZ ~ 63 HZ				
	Power capacity (KVA)	1.5	3.0	4.0	5.9	8.9
Levels of protection		IP20 (open type, IP protection rating for IEC products) Type1 (enclosed type, Type1 protection class for UL products)				

Table 4-2 Electrical Parameters (3-phase 380V~480V)

Project		Specifications				
Power (KW)		7.5	11	15	18.5	
Volume		A3		A4		
Out put	Adapt motor capacity (KW)	7.5	11	15	18.5	
	Rated output current (A)	17	25	32	37	
	Output voltage (V)	Three items from 0 to input voltage				
	Maximum output frequency	500 HZ (parameter parameter parameters)				
	Carrier frequency	0.5HZ~16.0HZ				
	Overload capacity	150%rated current 60S				
Rated input current (A)		20.5	26.0	35.0	38.5	
In put	Rated voltage, rated frequency	AC: 3-phase 380V~480V, 50 / 60 HZ				
	Voltage allowable fluctuation range	-15%~10%, the actual allowable range: AC 320V~528V				
	Frequency is allowed to fluctuation range	-5%~5%, the actual allowable range: 47.5HZ ~ 63 HZ				
	Power capacity (KVA)	11.0	17.0	21.0	21.0	24.0
Levels of protection		IP20 (open type, IP protection rating for IEC products) Type1 (enclosed type, Type1 protection class for UL products)				

Table 4-3 Electrical Parameters (3-phase 380V~480V)

Project		Specifications		
Power (kW)		22	30	37
Volume		A5	A6	
Out put	Adapt motor capacity (kW)	22	30	37
	Rated output current (A)	45	60	75
	Output voltage (V)	Three items from 0 to input voltage		
	Maximum output frequency	500 HZ (parameter parameter parameters)		
	Carrier frequency	0.5HZ~16.0HZ		
	Overload capacity	150%rated current 60S		
In put	Rated input current (A)	46.5	62.0	76.0
	Rated voltage, rated frequency	AC: 3-phase 380V~480V, 50 / 60 HZ		
	Voltage allowable fluctuation range	-15%~10%, the actual allowable range: AC 320V~528V		
	Frequency is allowed to fluctuation range	-5%~5%, the actual allowable range: 47.5HZ ~ 63 HZ		
	Power capacity (KVA)	30.0	40.0	57.0
Levels of protection		IP20 (open type, IP protection rating for IEC products) Type1 (enclosed type, Type1 protection class for UL products)		

Table 4-4 Electrical Parameters (3-phase 380V~480V)

Project		Specifications					
Power (kW)		45	55		75	90	110
Volume		A7			A8		A9
Out	Adapted motor capacity (kW)	45	55		75	90	110
	Rated output current (A)	91	112		150	176	210
put	Output voltage (V)	Three-phase 0 to input voltage					
	Maximum output frequency	500 HZ (parameter parameter parameters)					
	Carrier frequency	0.5HZ~16.0HZ					
	Overload capacity	150% rated current 60S					
In put	Rated input current (A)	92.0	113.0	157	157.0	180.0	214.0
	Rated voltage, rated frequency	AC: 3-phase 380V~480V, 50 / 60 HZ					
	Voltage allowable fluctuation range	-15%~10%, the actual allowable range: AC 320V~528V					
	Frequency is allowed to fluctuation range	-5%~5%, the actual allowable range: 47.5HZ ~ 63 HZ					
	Power Supply Capacity (KVA)	69.0	85.0	114	114.0	134.0	160.0
Levels of protection		IP20 (open type, IP, protection grade for IEC products) Type1 (enclosed type, Type1 protection class for UL products)					

4.2 Technical Specifications

Drive technical specificatio

Project		Specifications
Basic function	Maximal frequency	Vector control: 0~ 500Hz V / F control: 0~ 500Hz
	Carrier frequency	0.5kHz~16kHz The carrier frequency can be adjusted according to the load characteristics.
	Input the frequency resolution	Number setting: 0.01Hz Simulation setting: maximum frequency 0.025%
	Control mhoetd	Speed sensor-less vector control (SVC) Speed sensor vector control (FVC) V / F control
	Pull-in torque	G: 0.5Hz/150% (SVC) ; 0Hz/180% (FVC) P: 0.5Hz/100%
	Speed range	1: 100 (SVC) 1: 1000 (FVC)
	Steady speed accuracy	±0.5% (SVC) ±0.02% (FVC)
	Torque control accuracy	±5% (FVC)
	Overload capacity	G-type machine: 150% rated current 60s; 180% rated current 3s.P Model: 120% rated current 60s; 150% rated current 3s.
	Recurrent ascension	Automatic torque lifting; manual torque increase 0.1%~30.0%
	V/F curve	Three ways: straight; multipoint; N power V / F curve (1.2 Power, 1.4 power, 1.6 power, 1.8 power, 2 power)
V/F separation	2 ways: total separation, half separation	

	Add deceleration curve	Straight-line or S-curve acceleration and deceleration mode. Four kinds of acceleration and deceleration time, acceleration and deceleration time range 0.0~6500.0s
	DC braking	DC braking frequency: 0.00Hz~ maximum frequency Brake time: 0.0s~ 36.0s Brake action current value: 0.0%~100.0%
	Electronic control	Point-action frequency range: 0.00Hz~ 50.00Hz。 Tap-acceleration and deceleration time0.0s~6500.0s。
	Easy PLC / multiple-segment speed operation	Up to 16 segments are run by the built-in PLC or control terminal
	Built-in PID	It can easily realize the process control closed-loop control system
	Automatic Voltage Adjustment (AVR)	When the power grid voltage changes, it can automatically keep the output voltage constant
	Over pressure and over-loss speed control	Automatic limit current voltage during operation to prevent frequent overflow pressure trip
	Quick flow restriction function	Minimize overcurrent fault and protect the normal operation
	Torque limit and control	The characteristic of "excavator" automatically limits the torque during operation and prevent frequent excessive trip; the closed-loop vector mode can realize torque control
Personalized function	Excellent performance	Asynchronous motor and synchronous motor are controlled with high-performance current vector control technology
	Instantly stop	In the event of instantaneous power outage, the driver is maintained to operate for a short time
	Fast flow limit	Avoid the frequent overflow fault of the drive
	Invented IO	Five sets of virtual DIDO, which can achieve simple logic control
	Timing control	Timing control function: set the time range of 0.0Min~6500.0Min
	Multi-motor switching	Two sets of motor parameters, can realize the four motor switching control
	Motor overheating protection	The optional motor overheat expansion card accepts the motor temperature sensor input

Run	Command source	Operation panel given, control terminal given, serial communication port given. Command given source can be switched in several ways
	Frequency source	10 frequency sources: digital given, analog voltage given, analog current given, pulse given, serial port given. It can be switched in various ways
	Auxiliary frequency source	Of the 10 auxiliary frequency sources. It can flexibly assist frequency fine-tuning and frequency synthesis
	Input terminal	Standard: 5 DI digital input terminals (DI 1 to DI5), with DI 5 has the highest support 100 kHz (specified when ordering). 2 analog input terminals (AI1 to AI 2, AI 1 can only support 0 to 10 V voltage input, AI2 supports 0 to 10 V voltage input or 4 to 20 mA current input) Extended ability: 5 digital input terminals (DI 6 to DI 10) 1 analog input terminal (AI3), supporting -10~ 10V voltage input,

		And support for PT 100 \ PT1000
	Leading-out terminal	Standard: 1 high-speed pulse output terminal (FM), support the square wave signal output of 0 ~ 100 kHz (specified when ordering), can also be software set as ordinary digital output terminal 1 digital output terminal (DO 1) 1 relay output terminal (TA1-TB1-TC1) 1 analog output terminal (AO1), supporting 0 ~ 20 mA current output Extended ability: 1 analog output terminal (AO1), supporting 0-20 mA current or 0-10V voltage output 2 relay output terminals (TA2-TB2-TC2~TA3-TB3-TC3)
Control	The RS485 communication terminal	RS485 communication interface, and supports Modbus-RTU slave communication protocol
Display with the keyboard operation	LED show	Monitor the drive status parameters
	Monitor the drive status parameters	Lock part or all of the keys, define the scope of part of the keys, To prevent misoperation
	Defensive function	Short circuit detection of the electric motor, input and output phase deficiency protection, overcurrent protection and overvoltage protection Protection, underpressure protection, overheat protection, overload protection, etc
	Choose accessories	Brake assembly, IO expansion card, isolated RS485 communication card, differential input PG card, OC input PG card
Ambient	Where to use	Indoor, not directly exposed to the sun, no dust, corrosive gas, combustible gas, oil mist, water steam, dripping water or salt, etc
	Height above sea level	Below 1,000 m
	Ambient temperature	-10℃ ~ + 40℃ (ambient temperature in 40℃ ~ 50℃, please decrease the amount need)
	Humidity	Less-than95%RH, No water beads condensation
	Vibrance	Less-than5.9m/ (s ²) (0.6g)
	Storage temperature	- 20℃ ~ +60℃

4.3 Brake assembly type selection guide

Users can choose different resistance values and power according to the actual situation, (but the resistance value must not be less than the recommended value in the table, and the power can be large.) The selection of brake resistance needs to be determined according to the power of the motor in the actual application system, which is related to the system inertia, deceleration time, potential energy load energy, etc., and the customer needs to choose according to the actual situation. The greater the inertia of the system, the shorter the deceleration time required, and the more frequent the braking, the greater the braking resistance, the smaller the resistance value.

4.3.1 Selection of impedance values

When braking, almost all of the regeneration energy of the motor is consumed on the brake resistance.

According to the formula: $U^2 / R = P_b$

The braking voltage of the U system in the formula (Different systems are also different, for the 380VAC system generally take 700V) P_b braking power.

2.9.2 Power selection of the brake resistance

Theoretically, the power of the brake resistance is the same as the braking power, but considering the reduction is 70%.

According to the formula: $0.7 * P_r = P_b * D$
Power of the P_r resistance

D braking frequency (proportion of regeneration process to the whole working process)

Elevator: 20% ~30%

Open and take volumes 20 ~30%

Centrifuge will range from 50% to 60%

Accidental percent brake load 5%

Generally take 10%

Drive brake assembly type selection table Drive model	Recommended power of the brake resistance	Brake resistance The resistance value is recommended	Brake unit	Remark
HV320-R75G3/1R5P3	150W	$\geq 300\Omega$	Standard built-in	\
HV320-1R5G3/2R2P3	150W	$\geq 220\Omega$		
HV320-2R2G3/004P3	250W	$\geq 200\Omega$		
HV320-004G3	300W	$\geq 130\Omega$		
HV320-004G3/5R5P3	300W	$\geq 130\Omega$		
HV320-5R5G3/7R5P3	400W	$\geq 90\Omega$		
HV320-7R5G3	500W	$\geq 65\Omega$		
HV320-7R5G3/011P3	500W	$\geq 65\Omega$		
HV320-011G3/015P3	800W	$\geq 43\Omega$		
HV320-015G3	1000W	$\geq 32\Omega$		
HV320-015G3/018P3	1000W	$\geq 32\Omega$		
HV320-018G3/022P3	1300W	$\geq 25\Omega$		
HV320-022G3	1500W	$\geq 22\Omega$		
HV320-022G3/030P3	1500W	$\geq 22\Omega$		
HV320-030G3	2500W	$\geq 16\Omega$	Outlay	\
HV320-030G3/037P3	2500W	$\geq 16\Omega$		
HV320-037G3/045P3	3.7kW	$\geq 16\Omega$		
HV320-045G3	4.5kW	$\geq 16\Omega$		
HV320-045G3/055P3	4.5kW	$\geq 16\Omega$		
HV320-055G3/075P3	5.5kW	$\geq 8\Omega$		
HV320-075G3	7.5kW	$\geq 8\Omega$		
HV320-075G3/090P3	7.5kW	$\geq 8\Omega$		
HV320-090G3/110P3	4.5kW*2	$\geq 8\Omega*2$	\	
HV320-110G3/132P3	5.5kW*2	$\geq 8\Omega*2$		

Chapter 5 Installation and Wiring

5.1 Mechanical installation

5.1.1 Installation environment:

1. Ambient temperature: the ambient temperature has a great impact on the life of the driver. The operating ambient temperature of the drive is not allowed to exceed the allowable temperature range: $-10^{\circ}\text{C} \sim 50^{\circ}\text{C}$ (when the temperature exceeds 50°C , 1.5% for each 1°C increase).

2. Install the driver on the surface of a flame-retardant object, and there should be enough space around for heat dissipation. The driver is easy to generate a lot of heat when working. Install vertically on the mounting base with screws.

3. please install it in a place that is not easy to vibrate. The vibration shall not be greater than 0.6G. Pay special attention to stay away from the punch press and other equipment.

4. avoid installed in direct sunlight, wet, water drops.

5. Avoid places with corrosive, flammable and explosive gases in the air.

6. Avoid being installed in places with oil much dust and polymetallic dust

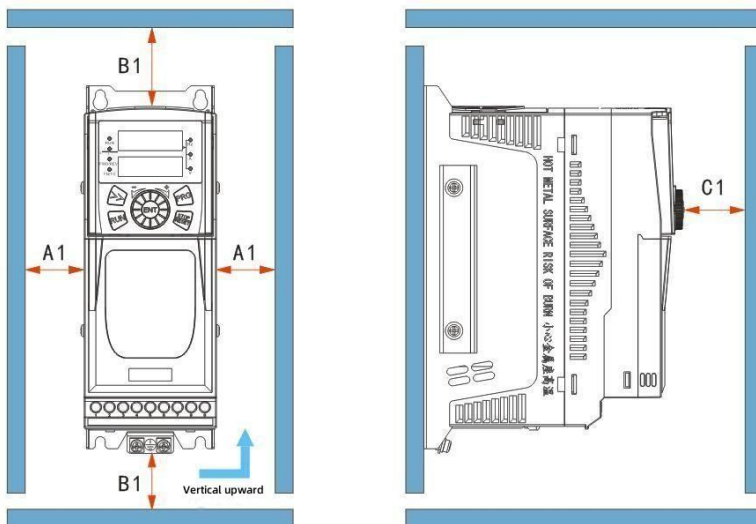

A Schematic diagram of the drive installation

Single installation: When the drive power is not greater than 22kW. When greater than 22kW, A should be greater than 50mm.

Up and down: install the heat insulation guide illustrated when the drive is installed up and down.

Power level	Installation size	
	B	A

≤15kW	≥100mm	Can make no request
18.5kW—30kW	≥200mm	≥50mm
≥37kW	≥300mm	≥50mm

5.1.2 Mechanical installation needs to pay attention to the heat dissipation problem. So please note the following points:

1. Please install the drive vertically, not inverted, to ensure that the heat is distributed upward. If there are more drives in the cabinet, it is best to install them side by side. In the case of the upper and lower installation, please refer to the diagram to install the heat insulation guide plate.

2. Follow the installation space as shown in the figure to ensure the heat dissipation space of the drive. However, please consider the heat dissipation of other devices in the cabinet when layout.

3. the installation bracket must be flame retardant material.

4. For the application occasions of metal dust, it is recommended to use the installation method outside the radiator cabinet. At this time, the fully sealed cabinet space should be as large as possible.

5.2 Electrical installation

5.1.3 Selection guidance of peripheral electrical components

Guidance on the selection of the peripheral electrical components of the drive.

Model	MCCB (A)	Contactora (A)	Input-side main loop leads mm ²	Output-side main loop wire mm ²	Control loop wire mm ²
HV320-R75G3/1R5P3	10	10	2.5	2.5	1.0
HV320-1R5G3/2R2P3	16	10	2.5	2.5	1.0
HV320-2R2G3/004P3	16	10	2.5	2.5	1.0
HV320-004G3	25	16	4.0	4.0	1.0
HV320-004G3/5R5P3	25	16	4.0	4.0	1.0
HV320-5R5G3/7R5P3	32	25	4.0	4.0	1.0
HV320-7R5G3	40	32	4.0	4.0	1.0
HV320-7R5G3/011P3	40	32	4.0	4.0	1.0
HV320-011G3/015P3	63	40	4.0	4.0	1.0
HV320-015G3	63	40	6.0	6.0	1.0
HV320-015G3/018P3	63	40	6.0	6.0	1.0
HV320-018G3/022P3	100	63	6	6.0	1.0

HV320-022G3	100	63	10	10	1.0
HV320-022G3/030P3	100	63	10	10	1.0
HV320-030G3	125	100	16	10	1.0
HV320-030G3/037P3	125	100	16	10	1.0
HV320-037G3/045P3	160	100	16	16	1.0
HV320-045G3	200	125	25	25	1.0

HV320-045G3/055P3	200	125	25	25	1.0
HV320-055G3/075P3	200	125	35	25	1.0
HV320-075G3	250	160	50	50	1.0
HV320-075G3/090P3	250	160	50	50	1.0
HV320-090G3/110P3	250	160	70	70	1.0
HV320-110G3/132P3	350	350	120	95	1.0

5.1.4 Instructions for the use of the peripheral electrical components

Instructions for the use of the electrical components around the drive

Accessories name	Installation site	Function declaration
Air switch	Enter the loop front end	The downstream equipment shall cut off the power supply when flowing over the current
Contactora	Between the open and drive input side	Drive is an all-on and power-off operation. Frequent power operation (less than twice per minute) or direct start operation should be avoided.
AC input transmitter	Drive input side	Increase the power factor on the input side; effectively eliminate the high harmonic on the input side, prevent the damage of other equipment caused by the voltage waveform distortion; eliminate the input current imbalance caused by the power interphase imbalance.
EMC input filter	Drive input side	Reduce the external conduction and radiation interference of the drive; reduce the conduction interference from the power supply end to the drive, and improve the anti-interference ability of the drive.
DC reactor	In series at the DC bus	Improve the power factor on the input side; improve the efficiency and thermal stability of the drive. Effectively eliminate the influence of the input side high harmonic on the driver and reduce the pair External conduction and radiation interference.
The AC-output reactor	Between the drive output side and the motor. Install close to the drive.	The output side of the driver generally contains more high-order harmonics. When the motor is far away from the driver Far away, because there is a large distribution of capacitance in the line. One of the harmonic may produce resonance in the loop, which brings two effects: damage the insulation performance of the motor, and will damage the motor for a long time. Generduce large leakage current, causing frequent driver protection. Generally, the distance between drive and motor exceeds 100m, so it is recommended to install and transport Out of the AC reactor.

5.15 Mode of connection Connecting mode of the main loop of the drive

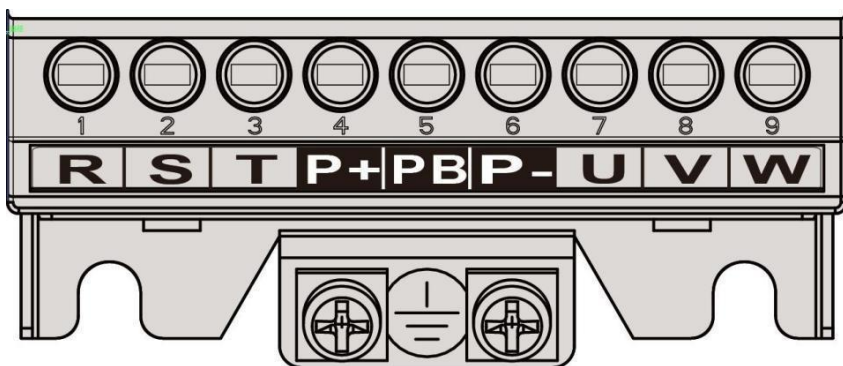

A 1-A 2 main circuit wiring terminal

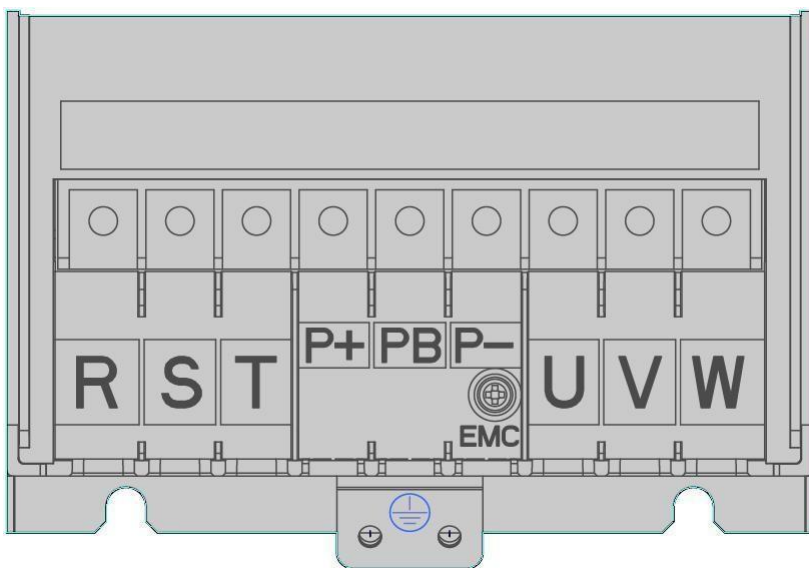

A 3-A 5 main circuit wiring terminal

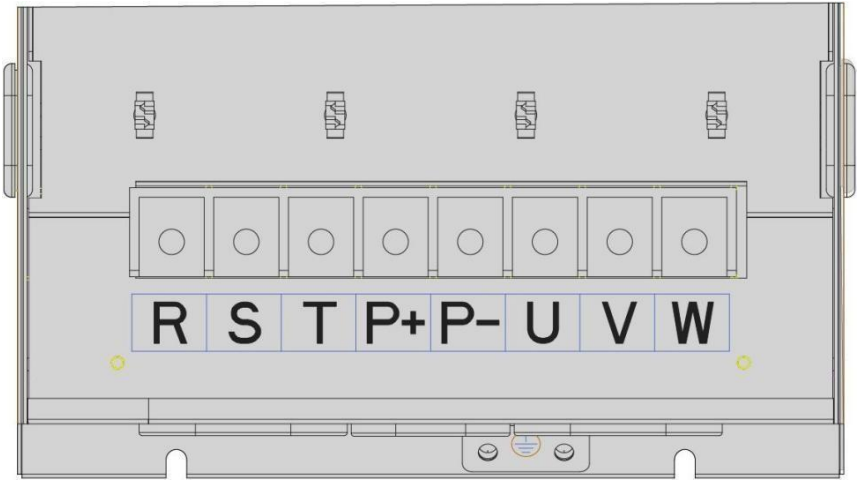

A6 Main circuit wiring terminal

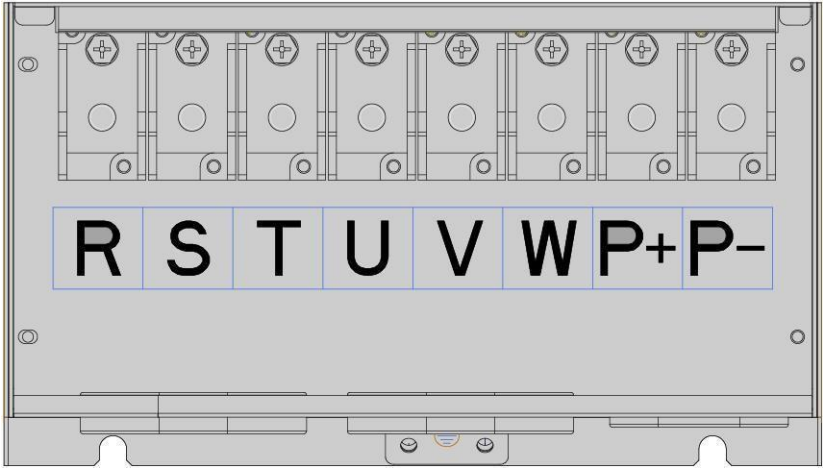

A7 Main circuit connection terminal

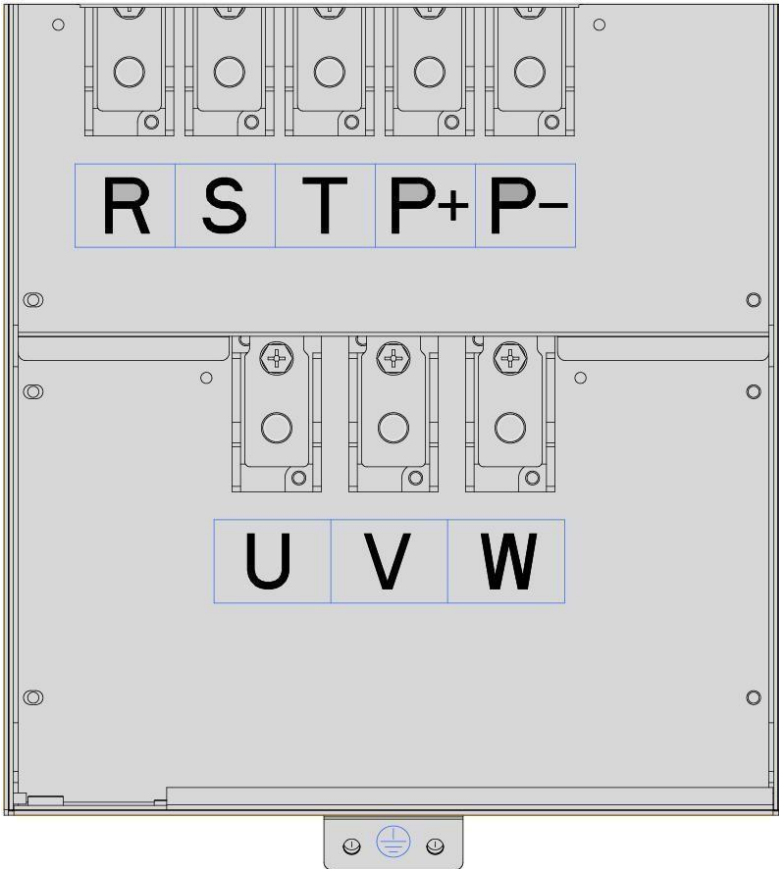

5.2.4 Terminal

instruction

Description of the drive main loop terminal:

Terminal mark	Designation	Illustration
R、S、T	Three-phase power supply input terminal	AC input three-phase power connection point
P+、P-	Positive and negative terminals of the DC bus line	DC bus connection point / external brake unit
P+、PB	Brake resistance connection terminal	External brake resistance connection point (model with built-in brake unit)
U、V、W	Drive output terminal	Connect to the three-phase motor

E	Earth terminal	Earth terminal
---	----------------	----------------

Wiring note:

1、 Input power supply R, S, T: the input side wiring of the driver, no phase sequence requirements.

2、 DC bus P + and P-terminals: pay attention to the residual voltage of DC bus P + and P-terminals just after the power failure, which must be contacted after being less than 36V, otherwise there is a risk of electric shock. P + and P when selected above 30kW, pay attention to external brake components -Polarity can not be reversed, otherwise cause drive damage or even fire.

3、 Brake resistance connection terminal P +, PB:

The brake resistance connection terminals are valid for models with built-in brake units below 22kW. The recommended value for brake resistance selection and the wiring distance shall be less than 5m. Otherwise it lead cause drive damage.

4、 Drive output side U, V, W:

The capacitor or surge absorber can not be connected to the drive side, otherwise the drive will be frequently protected or even damaged. When the motor cable is too long, due to the influence of the distributed capacitor, it is easy to produce electrical resonance, which will cause the damage of the motor insulation or produce a large leakage current to protect the drive overcurrent. When the length of the motor cable is greater than 100m, an AC output reactor shall be installed.

5、 Earth terminal:

The terminal must be reliably grounded, and the resistance value of the grounding wire must be less than 0.1 Ω . Otherwise, the equipment will cause abnormal operation or even damage. Do not share the ground terminal and the power supply zero line N terminal.

5.2.5 Drive control circuit wiring mode

5.2.6 Control terminals and wiring:

1: The layout diagram of the control circuit terminal is as follows:

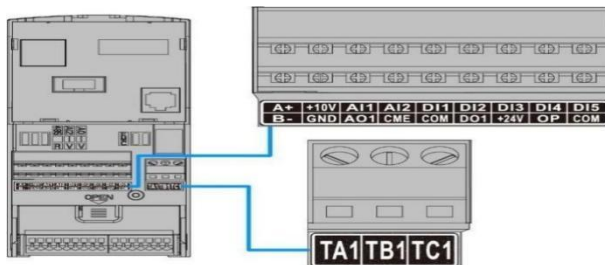

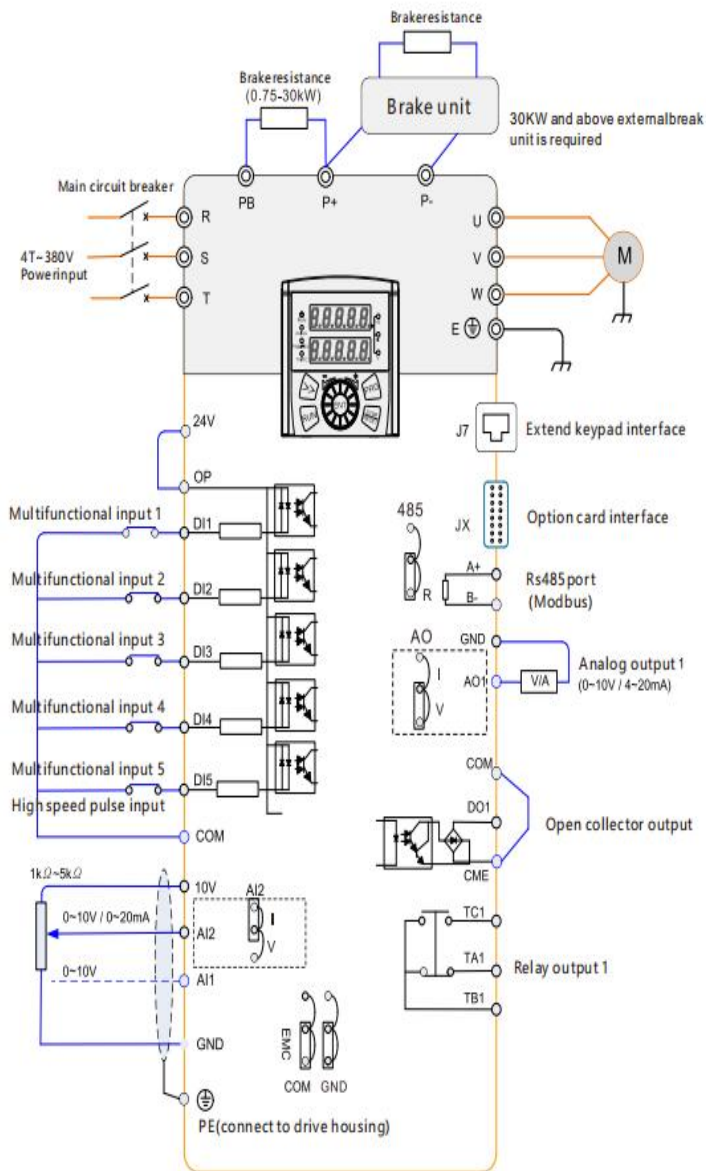

Drive control circuit wiring mode

2: Description of the control terminal function:

Category	Terminal symbol	Terminal name	Function declaration
Electric	+10V-GND	External connection with a + 10V power supply	Provide + 10V power supply, maximum output current: 10 mA Generally used as working power supply of external potentiometer, resistance range of potentiometer: 1k Ω ~5k Ω
	+24V-COM	External connection with a + 24V power supply	Provide + 24V power supply outward, generally used as a digital input and output terminal working power supply and External sensor power supply, the maximum output current: 100 mA
	OP	External power supply input terminal	Factory default with the + 24V connection When using external signals to drive DI 1 to DI 5, the OP shall be connected to the external power supply
Import imitate	AI1-GND	Analog quantity input terminal 1	1. Input voltage range: DC 0V~10V 2. Input impedance: 22 k Ω
	AI2-GND	Analog quantity input terminal2	1. Input range: DC 0V~10V / 0mA ~ 20 mA, by the control board superior J8 jump Line selection decision. 2. Input impedance: 22 k Ω at voltage input and 500 Ω at current input. 。
Digital input	DI1- OP	Digital input 1	1. light lotus root isolation, compatible with bipolar input 2. Input impedance: 4k Ω 3. the level input voltage range: 9V~30V
	DI2- OP	Digital input 2	
	DI3- OP	Digital input 3	
	DI4- OP	Digital input 4	
	DI5- OP	High-speed pulse input terminal	In addition to the characteristics of DI 1 to DI 4, it can also be used as a high-speed pulse input channel. Maximum input frequency: 100 kHz (this function is optional when ordering)
Number output	DO1-CME	Digital output 1	Optical lotus root isolation, bipolar open circuit collector output Output voltage range: 0V~24V Output current range: 0 mA ~ 50 mA Note: The digital output CME is internally isolated from the digital input COM, but it is delivered through the J10 jumper CME on the control board (The DO 1 defaults to the + 24V driver). When the DO 1 wants to drive with an external power source, the jumper must be removed.
	FM- CME	High speed pulse output	Subject to the function code P5-00 FM terminal Outmode Selection constraint When used as a high-speed pulse output, the highest frequency to 100 kHz; When open output as collector, as in DO 1 specification.

			Extended card selection
Analog output	AO1-GND	Analog output 1	The voltage or current output is selected by the J5 jumper on the control board. Output voltage range: 0V~10V Output current range: 0 mA ~ 20 mA
	AO2-GND	Analog output 2	The voltage or current output is determined by the J1 jumper selection on the expansion card. Output electricity Voltage range: 0V~10V output current range: 0 mA ~ 20 mA. Extended card selection

Category	Terminal symbol	Terminal name	Function declaration
Relay output	TA1-TB1	Often closed terminal	Contact drive capability: AC250V, 3A, COS ϕ =0.4. DC 30V, 1A
	TB1-TC1	Often closed terminal	
Relay output	TA2-TB2	Often closed terminal	Contact point drive capability: AC250V, 3A, COS ϕ =0.4. DC 30V, 1A Extended card selection
	TB2-TC2	Often closed terminal	
Relay output	TA3-TB3	Often closed terminal	Contact point drive capability: AC250V, 3A, COS ϕ =0.4. DC 30V, 1A Extended card selection
	TB3-TC3	Often closed terminal	
Message	A+-B-	Often closed terminal	RDI485 Communication interface
Auxiliary interface	JX	Function extension card interface	With the expansion card (I / O expansion card, communication card, PG card and other optional card) interface
	J7	External keyboard interface	External keyboard

5.3 Control terminal wiring instructions

1. Analog input terminal: because the weak analog voltage signal is particularly vulnerable to external interference, so generally need to use a shielded cable, and the wiring distance as short as possible, not more than 20m, in some analog signal is seriously disturbed, the analog signal source side needs to add a filter capacitor or ferrite magnetic core. The shielding layer of the analog terminal connects the PE on the driver side.

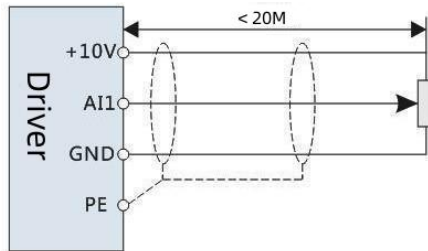

Schematic diagram of the analog quantity input terminal wiring

When the AI selects the current signal input, the AI is the current inflow direction, and the GND is the current outflow direction.

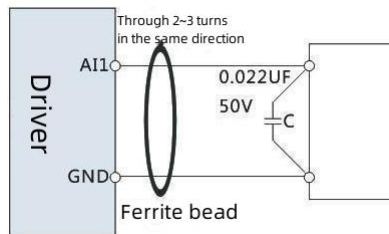

Analog quantity input terminal processing wiring diagram

Digital input
terminal wiring:
 Leakage wiring
 mode

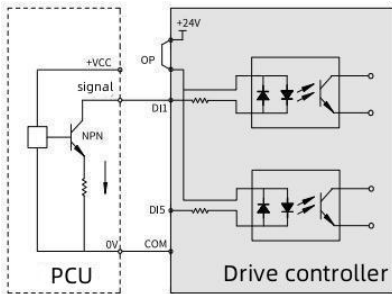

Use the leakage type connection method of the 24V power supply inside the drive

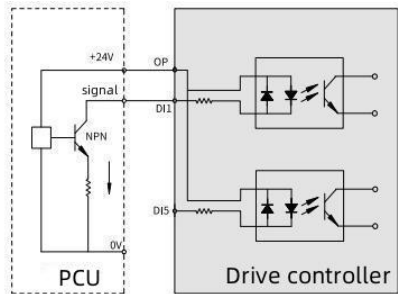

Use the leakage-type connection method of an external 24V power supply

The 24V power supply inside the drive is one of the most commonly used wiring methods, shorting the drive OP to the 24V terminal and connecting the frequency converter COM terminal to the 0V of the external controller.

If the external 24V power supply is used, the short connection between + 24V and OP must be removed, the 24V positive electrode of the external power supply must be connected to the OP terminal, and the external power supply 0V must be connected to the corresponding DI terminal after the controller control contact.

In this wiring mode, DI terminals of different drives cannot be connected together, otherwise it may cause DI misoperation; if DI terminals are connected together (between different drives), diodes shall be connected at DI terminals (anode to DI), including $I_F > 40 \text{ mA}$ and $V_R >$

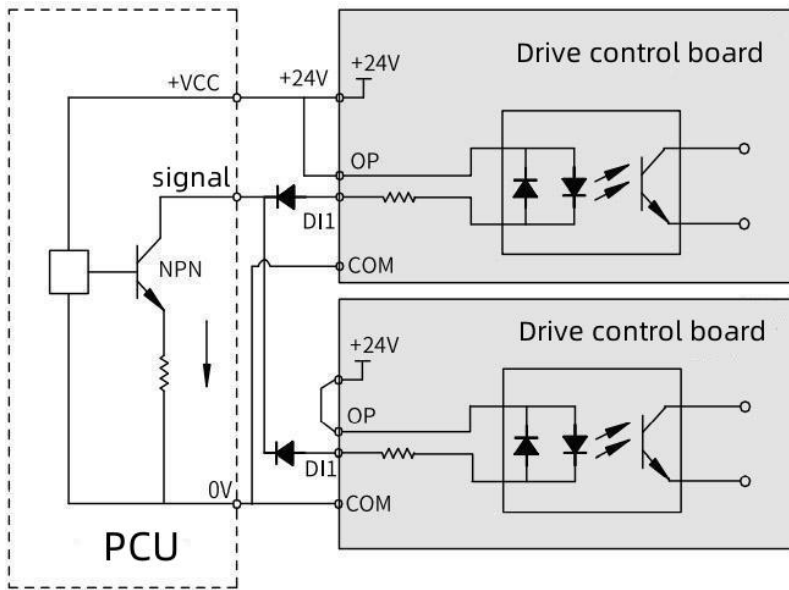

Multiple drive digital input terminals and leaky wiring mode

Source wiring mode

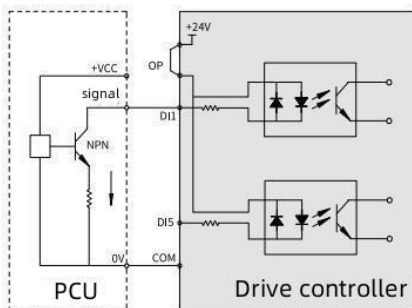

Use the leakage type connection method of the 24V power supply inside the drive

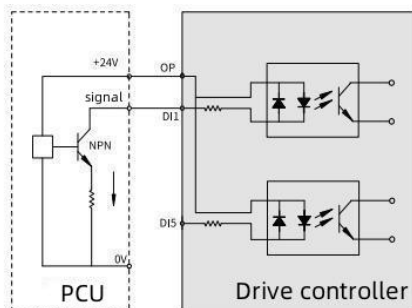

Use the leakage-type connection method of an external 24V power supply

Source wiring mode

If the 24V power supply inside the drive, the short circuit sheet between the +24V and the OP must be removed, connect the OP to the COM together, and connect the +24V with the common end of the external controller.

If the external power supply is used, the short connection between the + 24V and OP must be removed, the OP is connected to the 0V of the external power supply, and the positive electrode of the external power supply is connected to the corresponding DI terminal by the external controller.

2. Description of the control
signal terminal output

2. DO Digital Output Terminal:

When the digital output terminal needs to drive the relay, the absorption diodes shall be installed on both sides of the relay coil. Otherwise, it is easy to cause the DC 24V power supply damage. The driving capacity is no greater than 50 mA.

Note: Polarity of the absorption diode is installed properly, as illustrated in the following figure. Otherwise, when the digital output terminal has an output, the DC 24V power supply will be burned out.

CME and COM

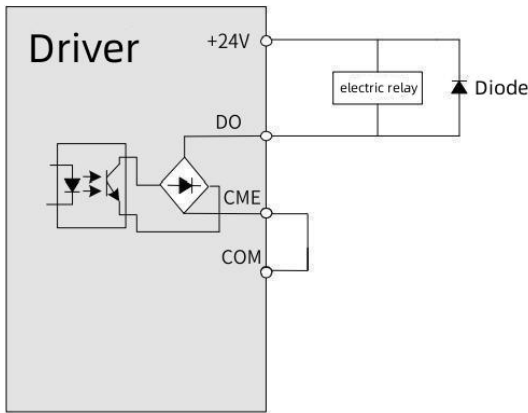

Digital output terminal wiring signal

Chapter 6 Operation and display application examples

6.1 Operation and display panel introduction

With the operation panel, the drive can be modified by functional parameters, working status monitoring and operation control (start and stop), etc. Its appearance and functional areas are shown in the following figure:



Schematic of the operation panel

6.1.1 Function indicator description:

- RUN: When the light is out, the drive is down, and when the light is on, the drive is in operation.
- FWD/REV: Forward and reverse indicator is in the reverse state.
- TN/TC: The tuning / torque control / fault indicator, the light is in torque control mode, the light flashing slowly is in tuning state, and the light flashing quickly is in fault state.
- LOC/REM: Start-stop control mode indicator, off panel control, long light indicates terminal control, flashing communication control
- Unit indicator lamp: Hz frequency unit, A current unit, V voltage unit, RPM (Hz + A) speed, % (A + V)
- Digital display area: 5-bit LED display, which can display the set frequency, output frequency, various monitoring data and alarm code, etc.

6.1.2 Keyboard button description table

Key-press	Definition	Function
PRG	Menu key	Primary menu enter or exit (switch from running display interface)

ENT	Enter	Enter the menu screen step by step and confirm the setting parameters
Knob clockwise	Increased key	Increment of the data or function code
Knob counterclockwise	Degradation key	Decression of data or functional codes
SHIFT	shift key	In the shutdown display interface and operation display interface, the display parameters can be selected periodically; When modifying the parameter, you can select the modification bit of the parameter;
RUN	Run the key	In the keyboard operation mode, used for running operations
STOP/RESET	Stop/reset	When running state, press this key can be used to stop running operation; when fault alarm state, can be used to reset the operation, the characteristics of this key is the function code P7-16 restriction.

6.2 Function code to view, modify the method description

The operation panel of the drive adopts the three-level menu structure for parameter setting and other operations. The three-level menu is respectively: function parameter group (first-level menu) function code (second-level menu) function code Setpoint (third-level menu). The operation procedure is shown in Fig.

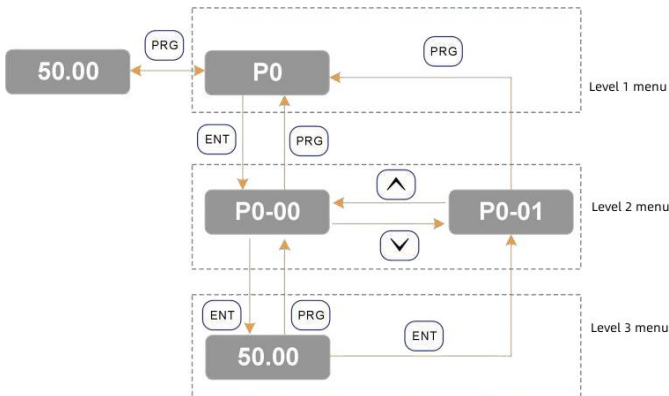

Flow chart of the three-level menu operation

Description: During the tertiary menu operation, press MENU or ENTER to return to the secondary menu. The difference between the two is: press ENTER to save the set parameters and return to the secondary menu, and automatically transfer to the next

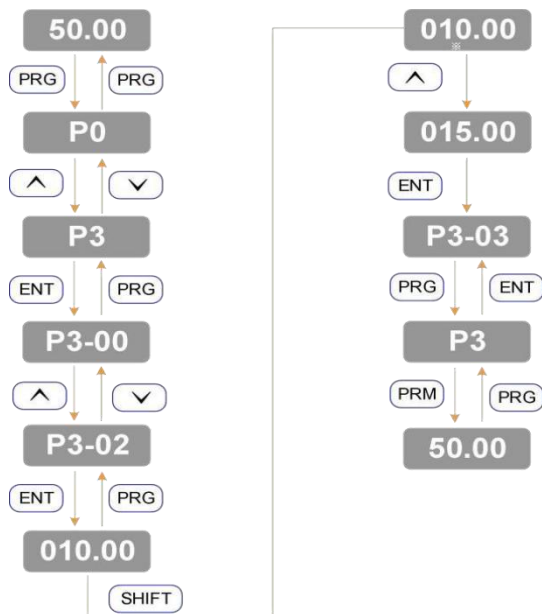

In the third level menu state, if the parameter is not flashing bit, the function code cannot be modified. The possible reasons are:

- 1) This function code is a non-modifiable parameter. Such as the actual detection parameters, operation record parameters, etc.
- 2) This function code can not be modified in the running state and can only be modified after shutdown.

6.3 How the drive function code is organized

The functional code group of the drive is as follows.

Functional code group	Functional description	Illustration
P0-PP	Universal drive function code	All functions are modified by this function code
H0~HC	Enhance the functional code group	Multiple motor parameters, AI / AO feature correction, optimization control, PLC card and other extension function
U0~U3	Run the state parameter group	Run state parameters

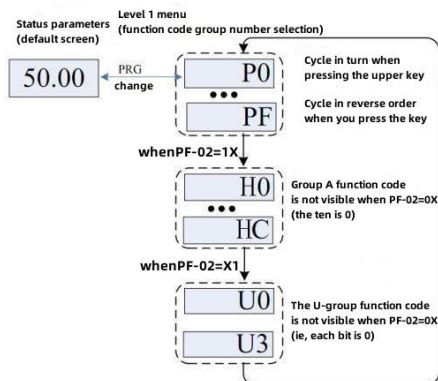

Function code group number browsing operation

The PP-02 function code is used to control whether the function code is displayed in group H and U groups or not.

PP-02	Initial value: 11		
	Set point	Decade	The unit
	Function	Group H displays the selection	Group U display selection
	Set the scope	0: Not displayed; 1: Not displayed	0: Not displayed; 1: Display

6.4 Review of the status parameters

In shutdown or running state, the shift key "" on the drive panel. Function codes P7-03 (operating parameter 1), P7-04 (operating parameter 2), and P7-05 (shutdown parameter) are selected according to the binary bits.

In the shutdown state, a total of 16 shutdown state parameters can be selected to display, respectively:

P7-05	LE shutdown display, showing the parameters	Bit00: (Hz)	Bit07:	33	☆
		Bit01: (V)	Bit08:		
		Bit02: DI	Bit09: PLC		
		Bit03: DO	Bit10:		
		Bit04: AI1 (V)	Bit11: PID		
		Bit05: AI2 (V)	Bit12: PULSE		
		Bit06: AI3 (V)			

Key sequence switch displays the selected parameters.

In the operating state, the five operating state parameters, including operating frequency, set frequency, bus voltage, output voltage and output current, are displayed by default. Whether the other parameters are set by P7-03 and P7-04 function codes:

P7-03	LED run display parameter 1	Bit00: (Hz) Bit01: (Hz) Bit02: Bit03: Bit04: (A) Bit05: (kW) Bit06: (%) Bit07: DI	Bit08: DO Bit09: AI1 (V) Bit10: AI2 (V) Bit11: AI3 (V) Bit12: Bit13: Bit14: Bit15: PID	1P	☆
P7-04	LED run display parameter 2	Bit00: PID Bit01: PLC Bit02: PULSE Bit03: (Hz) Bit04: Bit05: AI1 Bit06: AI2 Bit07: AI3	Bit08: Bit09: Bit10: Bit11: PULSE Bit12: Bit13: Bit14: X (Hz) Bit15: Y (Hz)	0	☆

After the drive is powered off, the power is on, and the displayed parameters are the parameters selected before the drive fails.

For example, if the user sets the parameters of the switching display as follows: operating frequency, bus voltage, output voltage, output current, output power, output torque, PID feedback, and encoder feedback speed, then the binary data is set according to the corresponding bits of the actual display data:

P7-03 - 0000 0000 0111 1101B

P7-04 - 0010 0000 0000 0001B

The conversion to the hexadecimal data is:

P7-03 -007DH

P7-04 -2001H

The keyboard Settings are displayed as P7-03: H.1043, and P7-04: H.2001

P7-17	Second row LED display parameters	0: Operating frequency of 1 (Hz) 1: Set Frequency (Hz) 2: Bus voltage 3: Output voltage	4: Output current (A) 5: Output power (kW) 6: Output torque: (%)	0	☆
-------	-----------------------------------	--	--	---	---

6.5 Start-stop control of the drive

6.5.1 Source selection of the start-stop signal

The start-stop control command of the driver has three sources, namely panel control, terminal control, communication control, and functional parameters P0-02 selection.

P0-02	Command source selection		Initial value: 0	Illustration
	Set the scope	0	Operation panel command channel (LED extinguish)	Press the RUN and STOP keys to start and stop
		1	Terminal command channel (LED bright)	The S-terminal should be defined as a start-stop command end
		2	Communication command channel (LED dodge bright)	The MODBUS-RTU protocol was used

6.5.1.1 Panel start-stop control

Through the keyboard operation, make the function code P0-02=0, which is the panel start-stop control mode, press the RUN key on the keyboard, the drive starts running (the RUN indicator light is on); when the drive is running, press the STOP key on the keyboard, the drive stops running (the RUN indicator light is off).

6.5.1.2 Terminal start and stop control

The terminal start and stop control mode is suitable for sampling dial switch and electromagnetic switch button as the start and stop occasions of the application system, and also suitable for the electrical design of the controller controlling the operation of the driver with the dry contact signal.

The A driver provides A variety of terminal control modes, which determines the input port of the switch signal mode through the function code P4-11 and the function codes P4-00~ P4-09. For specific setting methods, please refer to P4-11, P4-00~P4-09 for detailed explanation.

Example 1: It is required to use the drive dial switch as the drive start-stop switch, connect the forward running switch signal to DI2 port, and connect the reverse running switch signal to DI4 port. The use and setting methods are as follows:

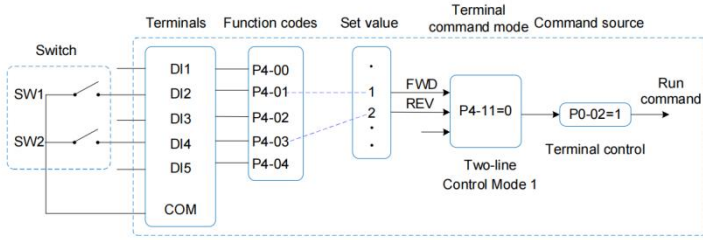

Example of the terminal start-stop control method

In the control mode above, the drive is running forward when the SW 1 command switch is closed and the drive is shut down when the SW 1 command switch is disconnected; When the SW 2 command switch is closed, the drive is running in reverse and when the SW 2 command switch is disconnected; the drive will stop when the SW 1 and SW 2 are closed at the same time.

Example 2: It is required to use the driver with the button electromagnetic as the drive start-stop switch, connect the start button signal to the DI2 port and the stop button signal to the DI3 port, and reverse the operation button signal to the DI4 port. The use and setting methods are shown in the figure as follows:

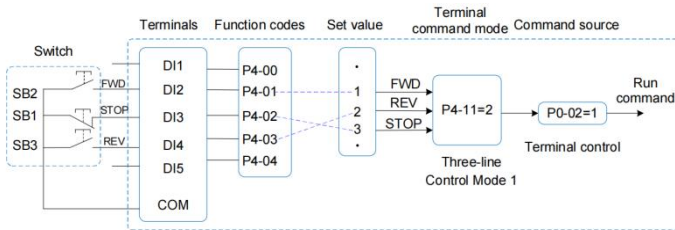

Example of the terminal start-stop control method

In the control mode of the figure above above, the SB 1 button must be kept closed during the shutdown; the command of SB 2 and SB 3 buttons is closed, and the operation state of the drive is subject to the last key action of the three buttons.

6.5.1.3 Communication start and stop control

Host computer in communication mode control drive operation has more and more applications, such as through RS485 network, can communicate with this series of drive, on the drive multi-function expansion port, insert the corresponding communication interface card, and select the control command source for communication mode (P0-02=2), can communication mode to control the drive start-stop running. Function codes related to communication setting are as follows:

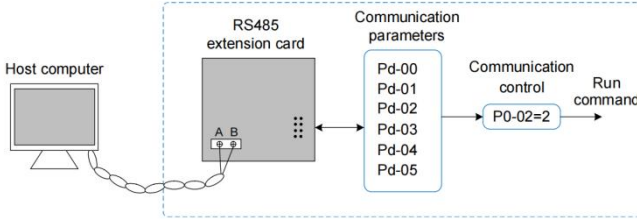

Example of communication start-stop control mode

In the figure above figure, the communication timeout time (Pd-04) function code is set to a value other than 0, that is, the function of automatic shutdown of the drive after the failure of the communication timeout is started, so as to avoid the uncontrolled operation of the drive caused by the communication line failure or the fault of the upper computer. This feature can be turned on in some apps.

The drive communication port is built into the MODBUS-RTU slave protocol, and the upper computer must communicate with the MODBUS-RTU master protocol. For the specific communication protocol, please refer to the detailed description of the RS485 communication Extension card in the manual.

There are three starting modes of the drive, namely, direct start, speed tracking and restart, and asynchronous machine preexcitation start. P6-00 = 0 is selected through the functional parameter P6-00, and the direct start mode is suitable for most small inertial loads. The frequency curve of the starting process is shown in the figure below. Its "DC brake" function before start is suitable for elevator and heavy load driving; "start frequency" is suitable for equipment driving, such as cement mixer equipment.

P6-00=1, the speed tracking and re-start mode is suitable for the drive of large inertial mechanical load. If the start process frequency curve is shown in the figure below. If the driver is starting and running, the load motor is still running by inertia, and the speed tracking can be started to avoid the occurrence of starting overflow.

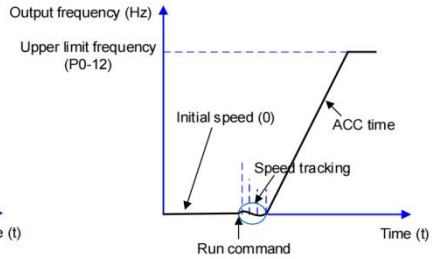
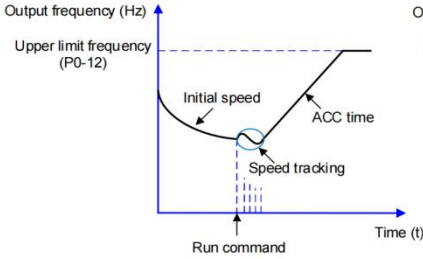

Speed tracking and reboot mode

P6-00=2, pre-excitation start mode, which is only suitable for induction motor load. Pre-excitation of the motor before starting can improve the rapid response characteristics of the Asynchronous motor and meet the application requirements of a relatively short acceleration time. The frequency curve of the starting process is as follows:

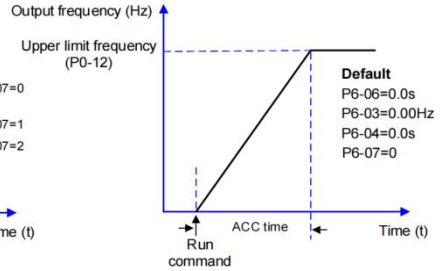
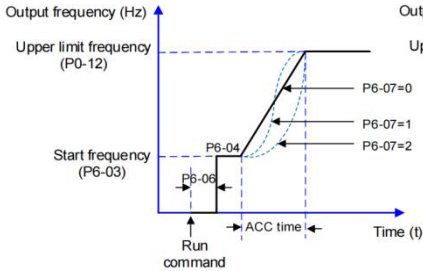

Pre-excitation start mode

6.5.1.4 Downtime mode

There are two shutdown modes of drive, namely deceleration stop and free stop, selected by function code P6-10

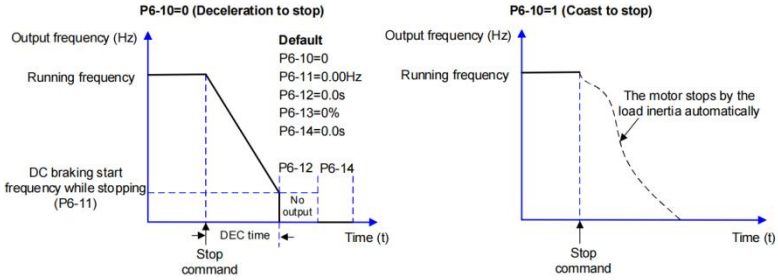

Downtime mode

6.5.1.5 Timed shutdown function

The drive supports the timing shutdown function through the P8-42, and the timing time is determined by P8-43 and P8-44.

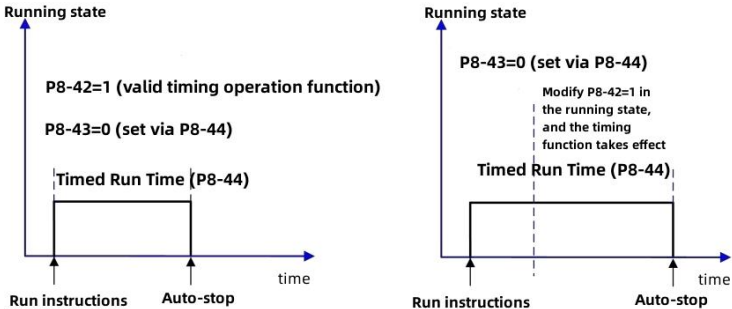

Timed shutdown function

For the length of the timing time, the user is also provided with the available analog amount (such as the potentiometer signal) for setting, please refer to P8-43 Detailed description of the functional code.

6.5.1.6 Point moving operation

In many applications, the driver needs to briefly run at low speed, easy to test the condition of the equipment, or other debugging actions, then it is used to run is more convenient.

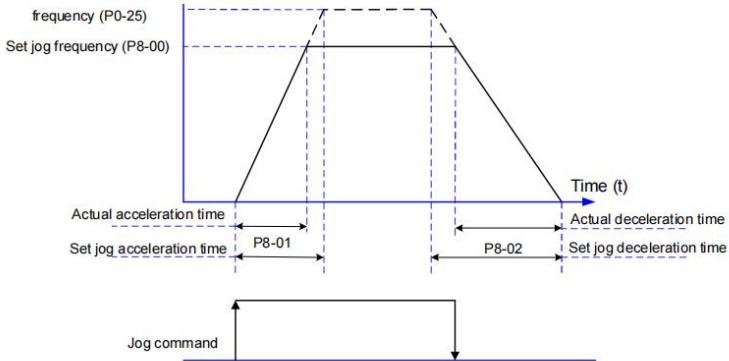

Point moving operation

6.5.1.7 The parameter setting and operation of the operation panel

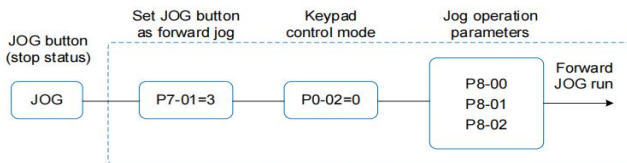

Operation panel point run

As shown in the figure above, after setting the relevant functional code parameters of the drive, press the JOG key when the drive is shut down, and the drive will start the positive turn operation at low speed, release the JOG key, and the drive will slow down and stop.

If the key dynamic reversal operation, set P7-01=4, and set P8-13=0, that is, allow the reversal operation, and then press JOG / QUICK key to operate.

Parameter setting and operation for running through the digital input port tap

In some production equipment that requires frequent use of point operation operation, such as textile machinery, it is more convenient to control the point operation with a button or a button. Related function codes are set as follows:

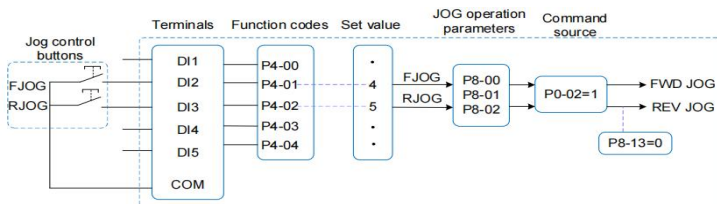

Communication S port point move running

After setting the above, the relevant function code parameters of the drive, press the JOG button when the drive is down, and the drive will start the low speed forward operation, release the JOG button, and the drive will slow down and stop. Similarly, press the JOG button to reverse the click operation.

6.5.1.8 Motor parameters required to be set

When the driver is running in the "vector control" (P0-01=0 or 1) mode, it has a strong dependence on the accurate motor parameters, which is one of the important differences with the "V / F control" (P0-01=2) mode. In order for the driver to have good driving performance and operation efficiency, the driver must obtain the accurate parameters of the controlled motor.

Required motor parameters are available (default function code for motor 1)

Motor 1 parameters	Parametric description	Illustration
P1-00	Motor type class	Aynchronous, frequency conversion asynchronous, synchronous
P1-01~P1-05	Rated power / voltage / current / frequency / rotational speed of the motor	Model parameters, manual input
P1-06~P1-20	Internal equivalent stator resistance, inductive resistance, rotor inductor, etc	Tuning parameters
P1-27~P1-34	Encoder parameters, with the sensor vector mode needs to be set	Encoder parameters

6.6.1 Automatic tuning and identification of the motor parameters

The methods to obtain the internal electrical parameters of the controlled motor include dynamic identification, static identification, manual input motor parameters, etc.

Automatic tuning step of machine parameters is as follows:

Identification method	Applicable situation	Identify the effect
No-load dynamic identification	Suitable for synchronous motor, asynchronous motor. Motor and application system convenient away from the occasion	the best
Carry dynamic identification	Suitable for synchronous motor, asynchronous motor. Motor and the application system is not convenient to break away from the occasion	pretty good
Static identification	Only suitable for asynchronous motor, motor and load are difficult to separate, and do not allow dynamic identification operation occasion	range
Manual input parameters	Suitable for Asynchronous motors only. Motor and application system is difficult to separate from the occasion, will be the previous drive Successfully identified motor parameters of the same model are copied and input to the corresponding function code of P1-00~P1-10	may

The parameter identification method of default motor 1 is explained below as an example. The identification method of motor 2 is the same, but the function code number should be changed accordingly.

Step 1: if the motor can be completely removed from the load, in the case of power failure, mechanically remove the motor from the load part, so that the motor can rotate freely without load.

Step 2: After power, select the drive command source (P0-02) as the operation panel command channel.

Step 3: Accurately input the nameplate parameters of the motor (such as P1-00~P1-05), please input the following parameters according to the actual parameters of the motor (select according to the current motor):

Motor selection	Parameter
Motor 1	P1-00:, Motor type selection P1-01:, motor rated power P1-02:, rated voltage of motor P1-03:, rated current of motor P1-04: rated frequency P1-05, rated speed of motor
Motor 2	H2-00~H2-05: the same definition as described above

Step 4: If it is an asynchronous motor, P1-37 (tuning selection, for motor 2, corresponding to H2-37 function code), please select 2 (asynchronous machine complete tuning), press ENTER to confirm, at this time, the keyboard displays TUNE, as shown in the figure below:

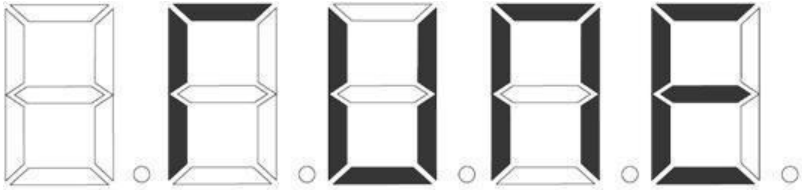

RUN Then press the RUN key on the keyboard panel, and the driver will drive the motor to accelerate and slow, reverse and run, the operation indicator light is on, and identify the operation duration for about 2 minutes. When the above display information disappears, return to the normal parameter display state, indicating the completion of tuning. After this complete tuning, the driver will automatically calculate the following parameters of the motor:

Motor selection	Parameter
Motor 1	P1-06: Asynchronous motor stator resistance P1-07: Asynchronous motor rotor resistance P1-08: leakage resistance of Asynchronous motor P1-09: mutual resistance of Asynchronous motor P1-10: No-load current of Asynchronous motor
Motor 2	H2-06~H2-10: the same definition as described above

If the motor is completely disconnected, P1-37 (motor 2 is H2-37), select 1 (Asynchronous still tuning) and press the RUN key on the keyboard panel to start identifying the motor parameters.

Description on synchronous motor identification:

Due to the synchronous machine system driven by A810, the encoder feedback signal is required, and the parameters of the encoder should be correctly set up before identification. During the identification process of the synchronous machine system, there must be rotation action, and the best identification method is no-load dynamic identification. Besides, the conditions are not allowed.

Chapter 7 Functional parameter table

PP-00 is set to the non-0 value, that is, the parameter protection password is set. In the function parameter mode and the user change parameter mode, the parameter menu must be entered after entering the password correctly. The password is cancelled, and PP-00 should be set to 0.

The parameter menu in user custom parameter mode is not password protected.

The symbols in the function table are described as follows:

"☆": It means that the set point of this parameter can be changed when the drive is shut down or running.

"★": Indicates that the setting value of this parameter cannot be changed when the drive is in the running state.

"●": It means that the value of this parameter is the actual detected recorded value and cannot be changed.

"*": It means that the parameter is "manufacturer parameter", only for the manufacturer, the user is prohibited to operate.

7.1 Table of basic function parameters

FC	Designation	Set the scope	Initial value	Change
P0 basic function group				
P0-00	GP type is shown	1: Model G (constant torque load model) 2: P type (fan and water pump load type)	Model determination	●
P0-01	1st Motor control mode	0: No speed sensor, vector control (SVC) 1: Speed sensor vector control (PVC) 2: V / F control	2	★
P0-02	Command source selection	0: Operation panel command channel (LED out) 1: Terminal command channel (LED bright) 2: Communication command channel (LED flashing)	0	☆

P0-03	Main frequency source X selection	0: Digital setting (preset frequency P0-08, UP / DOWN can be modified, power loss is not remembered) 1: Digital setting (preset frequency P0-08, UP / DOWN can be modified, power loss memory) 2: AI1 3: AI2 4: AI3 (panel potentiometer) 5: PULSE Pulse setting (DI5) 6: Multiple instructions 7: Simple PLC 8: PID 9: Communication given	1	★
P0-04	Secondary frequency source Y selection	With P0-03 (main frequency source X selection)	0	★
P0-05	Auxiliary frequency source Y range selection when superposition	0: relative to the maximum frequency 1: relative to the frequency source X	0	☆
P0-06	Auxiliary frequency source Y fan when superposition Around	0%~150%	100%	☆
P0-07	Frequency source superposition selection	Individual bit: frequency source selection 0: Main frequency source X	00	☆
FC	Designation	Set the scope	Initial value	Change
		1: Main and auxiliary operation results (operation relationship is determined by ten digits) 2: The main frequency source X and the auxiliary frequency source Y switch 3: The main frequency source X and the main and auxiliary operation results switch 4: auxiliary frequency source Y and main and auxiliary operation results switch ten place: frequency source main and auxiliary operation relationship 0: Main + auxiliary 1: Master-auxiliary 2: Maximum value of both cases 3: Minimum value of both cases		
P0-08	Preset frequency	0.00Hz~ Maximum frequency (P0-10)	50.00Hz	☆
P0-09	Running direction	0: The direction is the same 1: The opposite direction	0	☆
P0-10	maximun-frequency	50.00Hz~500.0Hz	50.00Hz	★
P0-11	Upper limit frequency source	0: P0-12 setting 1: AI1 2: AI2 3: AI3 4: PULSE pulse setting 5: Communication given	0	★
P0-12	Upper limiting frequency	Lower limit frequency P0-14 to maximum frequency P0-10	50.00Hz	☆
P0-13	Upper limit frequency	0.00Hz~maximun-frequency P0-10	0.00Hz	☆

	bias			
P0-14	Lower limit frequency	0.00kHz~upper limiting frequencyP0-12	0.00Hz	☆
P0-15	Lower limit frequency	0.5kHz~16.0kHz	Model determinat ion	☆
P0-16	Carrier frequency and temperature adjustment	0: No.1: Yes	1	☆
P0-17	Acceleration time 1	0.00s~650.00s (P0-19=2) 0.0s~6500.0s (P0-19=1) 0s~6500s (P0-19=0)	Model determinat	☆
P0-18	Slow down time 1	0.00s~65000s	Model determinat	☆
P0-19	Time unit of acceleration and deceleration	0: 1S 1: 0.1S 2: 0.01S	1	★
P0-21	Auxiliary frequency source bias during superposition Place the frequency	0.00Hz~maximun-frequency P0-10	0.00Hz	☆
P0-22	Frequency command resolution	2: 0.01Hz	2	★
P0-23	Digital setting frequency shutdown memory selection	0: No memory 1: Memory	1	☆
P0-24	Motor selection	0: Motor 1 1: Motor 2	0	★
P0-25	Acceleration of deceleration time reference frequency	0: Maximum frequency (P0-10) 1: Set the frequency 2: 100Hz	0	★
P0-26	Runtime frequency instruction UP/DOWN baseline	0: Operating frequency 1: Set the frequency	0	★
P0-27	Command source bundle frequency source	Individual bit: action panel command binding frequency source selection 0: No binding 1: Number setting frequency 2: AI1 3: AI2 4: AI3 5: PULSE Pulse setting (DI5) 6: Multi-section speed 7: Simple PLC 8: PID 9: Communication given Ten places: terminal command binding frequency source selection 100 bits: communication command binding frequency source selection Thousand bits: automatically run the binding frequency source selection	0000	☆
P0-28	Communication extension card type	0: Modbus communication card	0	☆
P1 first motor parameters				
P1-00	Motor type selection	0: Ordinary Asynchronous motor 1: variable frequency induction motor	0	★

P1-01	The motor is rated power	0.1kW~1000.0kW	Model determination	★
P1-02	The motor is rated voltage	1V~2000V	Model determination	★
P1-03	Rated current of motor	0.01A~655.35A (Drive power <=55kW) 0.1A~6553.5A (Drive power> 55kW)	Model determination	★
P1-04	Rated frequency of motor	At 0.01Hz~ the maximum frequency	Model determination	★
P1-05	Motor rated speed	1rpm~6553rpm	Model determination	★
P1-06	Asynchronous motor stator resistance	0.001 Ω ~65.535 Ω (drive power <=55kW) 0.0001 Ω ~6.5535 Ω (Drive power> 55kW)	Tuning parameters	★
P1-07	Asynchronous motor rotor resistance	0.001 Ω ~65.535 Ω (drive power <=55kW) 0.0001 Ω ~6.5535 Ω (Drive power> 55kW)	Tuning parameters	★
P1-08	Leakage resistance of Asynchronous motor	0.01 mH ~ 655.35mH (drive power <=55kW) 0.001 mH ~ 65.535mH (Drive power> 55kW)	Tuning parameters	★
P1-09	Mutual inductive resistance of Asynchronous motor	0.1mH~6553.5mH (Drive power <=55kW) 0.01mH~655.35mH (Drive power> 55kW)	Tuning parameters	★
P1-10	No-load current of Asynchronous motor	0.01A~P1-03 (Drive power <=55kW) 0.1A~P1-03 (Drive power> 55kW)	Tuning parameters	★
P1-27	Number of encoder lines	1~65535	1024	★
P1-28	Encoder type	0: The ABZ incremental encoder 1: The UVW incremental encoder 2: Rotary transformer 3: A cosine encoder 4: provincial line UVW encoder	0	★
P1-30	The ABZ Incremental encoder AB phase order	0: Positive 1: Reverse	0	★
P1-31	Encoder installation angle	0.0~359.9°	0.0°	★
P1-32	The UVW encoder has a UVW phase sequence	0: Positive 1: Reverse	0	★
P1-33	The UVW encoder bias angle	0.0~359.9°	0.0°	★
P1-34	Rotary transformer pole-log	1~65535	1	★
P1-36	Speed feedback PG break detection	0.0: No action	0.0	★

FC	Designation	Set the scope	Factory	Change
	Time	0.1s ~10.0s		
P1-37	Tune selection	0: No operation 1: asynchronous machine static tuning 2: Complete tuning of asynchronous 3: Aynnof static static complete machine	0	★
First motor vector control parameters of the P2 group				
P2-00	The velocity-ring proportional gain of 1	1 ~100	30	☆
P2-01	The velocity loop integration time of 1	0.01s ~10.00s	0.50s	☆
P2-02	Switch frequency 1	0.00 ~F2-05	5.00Hz	☆
P2-03	The velocity-loop proportional gain of 2	1 ~100	20	☆
P2-04	The velocity loop integration time 2	0.01s ~10.00s	1.00s	☆
P2-05	Switch frequency 2	F2-02 to the maximum frequency	10.00Hz	☆
P2-06	Vector-controlled turn-difference gain	50%~200%	100%	☆
P2-07	The velocity loop filtering time constant	0.000s~0.100s	0.050s	☆
P2-09	Torque upper limit instruction selection under speed control mode	0: Parameter P2-10 is set 1: AI1 2: AI2 3: AI3 4: Pulse (DI5) 5: Communication given 6: MIN (AI1,AI2) 7: MAX (AI1,AI2) The full range of options 1-7 corresponds to P2-10	0	☆
P2-10	Torque under the speed control mode Upper limit number setting	0.0% ~ 200.0%	150.0%	☆
P2-11	The upper limit of the torque under the speed control mode Order selection (power generation)	0: Parameter P2-10 setting (distinction between electric and power generation) 1: AI1 2: AI2 3: AI3 4: PULSE pulse setting 5: Communication given 6: MIN (AI1,AI2) 7: MAX (AI1,AI2) 8: Parameter P2-12 is set The full range of the 1-7 options corresponds to P2-12	0	☆
P2-12	Number setting of torque upper limit under speed control mode (power generation)	0.0% ~ 200.0%	150.0%	☆

P2-13	Excitation regulation proportional gain	0 ~ 60000	2000	☆
P2-14	Excitation regulation of integral gain	0 ~ 60000	1300	☆
P2-15	Torque regulation proportional gain	0 ~ 60000	2000	☆
P2-16	Torque adjustment integral gain	0 ~ 60000	1300	☆
P2-17	The velocity loop integral property	Individual bit: integral separation 0: invalid 1: valid	0	☆

FC	Designation	Set the scope	Initial value	Change
P2-20	Over-modulated voltage factor	100%~110%	105%	★
P2-21	Moment coefficient of the constant power region	50%~200%	100%	☆
P2-22	Power generation power limiting enabling	0: invalid 1: Effective throughout the whole process 2: Effective at constant speed 3: The deceleration takes effect	0	☆
The V / F control parameters in group				
P3-00	V/F curve setting	0: Line V / F 1: Multipoint V / F 2: Square V / F 3:1.2 Power V / F 4:1.4 Power V / F 6:1.6 Power V / F 8:1.8 Power V / F 9: Keep 10: V / F fully separated mode 11: V / F semi-separation mode	0	★
P3-01	Recurrent ascension	0.0%: (Automatic torque lift) 0.1%~30.0%	Model determination	☆
P3-02	Torque lift cutoff frequency	0.00Hz~ the maximum frequency	50.00Hz	★
P3-03	Multipoint V / F frequency point 1	0.00Hz~P3-05	0.00Hz	★
P3-04	Multipoint V / F voltage point 1	0.0%~100.0%	0.0%	★
P3-05	Multipoint V / F frequency point 2	P3-03~P3-07	0.00Hz	★

P3-06	Multipoint V / F voltage point 2	0.0%~100.0%	0.0%	★
P3-07	Multipoint V / F frequency point 3	P3-05-Motor rated frequency (P1-04)	0.00Hz	★
P3-08	Multi-point V / F voltage point 3	0.0%~100.0%	0.0%	★
P3-09	V / F transition compensation gain	0.0%~200.0%	0.0%	☆
P3-10	V / F overexcitation gain	0~200	64	☆
P3-11	V / F oscillations of the inhibitory gain	0~100	Model determination	☆
P3-13	V / F separated voltage source	0: Number setting (P3-14) 1: AI1 2: AI2 3: AI3 4: PULSE Pulse setting (DI5) 5: Multiple instructions 6: Simple PLC 7: PID 8: Communication given Note: 100.0% corresponds to the rated motor voltage	0	☆
P3-14	V / F separate voltage number setting	0 V ~tmotor rated voltage	0V	☆
P3-15	Voltage rise time for V / F separation	0.0s~1000.0s Note: represents the time from 0V changes to the rated motor voltage	0.0s	☆

	Designation	Set the scope	Initial value	Change
P3-16	V / F separation Between	0.0s~1000.0s Note: represents the time from 0V changes to the rated motor voltage	0.0s	☆
P3-17	V / F separation and shutdown mode	0: frequency / voltage independently reduced to 0 1: The frequency is reduced after the voltage is reduced to 0	0	★
P3-18	Turn-difference compensation time constan	0.02s~1.00s	0.50s	☆
P3-19	Online torque compensation gain	80%~150%	100%	★
P4 group of input terminal				

P4-00	DI1 terminal function selection	0: No function 1: Forward to running a FWD or running a command 2: Inse the REV or the direction (Note: When set to 1 and 2, it should be used with P4-11, see the function code parameters for details) 3: Three-line operation control 4: Forward movement (FJOG) 5: Reverse point movement (RJOG) 6: Terminal UP 7: Terminal DOWN 8: Free parking 9: Fault reset (RESET) 10: Operation pause 11: External fault often open input 12: Multiple segment command terminal 1 13: Multiple segment command terminal 2 14: Multiple segment command terminal 3 15: Multiple segment command terminal 4 16: Select the terminal 1 for the acceleration and deceleration time 17: Select terminal 2 for the acceleration and deceleration time 18: frequency source switching 19: UP / DOWN set reset (terminal, keyboard) 20: Control command to switch terminal 1 21: acceleration and deceleration prohibition 22: The PID is paused 23: The PLC state is reset 24: swing frequency pause 25: Counter input 26: Counter is reset 27: Length count input 28: Length is reset 29: Torque control is prohibited 30: PULSE (Pulse) frequency input (for DI5 only valid) 31: Keep 32: immediate DC braking 33: External fault is frequently closed for input 34: Frequency modification is enabled 35: PID, the action direction is reversed 36: External parking terminal 1 37: Control command to switch terminal 2 38: The PID points are paused 39: Frequency source X, switch with the preset frequency 40: The frequency source Y, and switch with the preset frequency 41: Motor selection terminal 1 42: Motor selection terminal 2 43: PID parameter switching 44: User-defined fault 1 45: User-defined custom fault 2 46: Speed control / torque control switch	1	★
P4-01	DI2 terminal function selection		4	★
P4-02	DI3 terminal function selection		9	★
P4-03	DI4 terminal function selection		12	★
P4-04	DI5 terminal function selection		13	★
P4-05	DI6 terminal function selection		0	★
P4-06	DI7 terminal function selection		0	★
P4-07	DI8 terminal function selection		0	★
P4-08	DI9 terminal function selection		0	★
P4-09	DI10 terminal function selection	0	★	

		47: Emergency stop 48: External parking terminal 2 49: Reduce the DC brake 50: The operation time is cleared 51: Two line / three line switch 52: Reverse frequency is prohibited 53-59: Retention		
FC	Designation	Set the scope	Initial value	Change
P4-10	DI digital input terminal filter time	0.000s~1.000s	0.010s	☆
P4-11	Terminal command mode	0: two lines type 1 1: two lines type 2 2: three line 1 3: three line 2	0	★
P4-12	Rate of change of the terminal UP / DOWN	0.001Hz/s~65.535Hz/s	1.00Hz/s	☆
P4-13	Analog input curve 1 minimum input	0.00V~P4-15	0.00V	☆
P4-14	Simulated input curve 1 minimum lose Enter the corresponding setting	-100.0%~+100.0%	0.0%	☆
P4-15	Analog input curve 1 maximum input	P4-13~+10.00V	10.00V	☆
P4-16	Simulated input curve of 1 max-lose Enter the corresponding setting	-100.0%~+100.0%	100.0%	☆
P4-17	AI1 filtering time	0.00s~10.00s	0.10s	☆
P4-18	Analog input curve 2 minimum input	2.00V~P4-20	0.00V	☆
P4-19	Simulated input curve 2 minimum lose Enter the corresponding setting	-100.0%~+100.0%	0.0%	☆
P4-20	Analog input curve 2 maximum input	P4-18~+10.00V	10.00V	☆
P4-21	Simulated input curve of 2 max-lose Enter the corresponding setting	-100.0%~+100.0%	100.0%	☆
P4-22	AI2 filtering time	0.00s~10.00s	0.10s	☆

P4-23	Analog input curve 3 minimum input	-10.00V~P4-25	0.5V	☆
P4-24	Simulated input curve 3 minimum lose Enter the corresponding setting	-100.0%~+100.0%	0.0%	☆
P4-25	Analog input curve 3 maximum input	P4-23~+10.00V	6.6V	☆
P4-26	Simulated input curve 3 max-lose Enter the corresponding setting	-100.0%~+100.0%	100.0%	☆
P4-27	AI3 filtering time	0.00s~10.00s	0.50s	☆
P4-28	PULSE minimum input	0.00kHz~P4-30	0.00kHz	☆
P4-29	PULSE minimum input corresponds to the input setting	-100.0%~100.0%	0.0%	☆
P4-30	PULSE maximum input	P4-28~100.00kHz	50.00kHz	☆
FC	Designation	Set the scope	Initial value	Change
P4-31	PULSE maximum input setting	-100.0%~100.0%	100.0%	☆
P4-32	PULSE filtering time	0.00s~10.00s	0.10s	☆
P4-33	Simulate the input curve selection	Individual bit: AI1 curve selection 1: Curve 1 (2 points, see P4-13~P4-16) 2: Curve 2 (2 points, see P4-18~P4-21) 3: Curve 3 (2 points, see P4-23~P4-26) 4: Curve 4 (4 points, see H6-00~H6-07) 5: curve 5 (4 points, see H6-08~H6-15) Ten places: AI2 curve selection, the same as above Hundred bits: AI3 curve selection, identical to above	321	☆
P4-34	The analog input is below the minimum input setting selection	Individual bit: AI1 is below the minimum input setting selection 0:1:0.0% Ten: AI2 is below the minimum input setting selection, the same hundred: AI3 is below the minimum input setting selection, the same as above	000	☆
P4-35	DI1 delay time	0.0s~3600.0s	0.0s	☆
P4-36	DI2 delay time	0.0s~3600.0s	0.0s	☆
P4-37	DI3 delay time	0.0s~3600.0s	0.0s	☆
P4-38	DI digital input terminal valid mode selection 1	0: high level 1: Effective at the low level One digit: DI1 ten: DI2 100 digits: DI3 thousand: DI4 0,000 digits: DI5	00000	★
P4-39	DI digital input terminal terminal valid mode selection 2	0: high level 1: Effective at the low level One: DI6 10: DI7 100: DI8 thousand: DI9 0,000: DI10	00000	★
P5 group of output terminal				

P5-00	FM and AO2 terminal output mode selection	Individual bit: FM terminal function selection 0: pulse output 1: Switch quantity output (TA2-TB2-TC2) Ten place: AO2 terminal function selection 0: analog output 1: Switch volume output (TA3-TB3-TC3)	00	☆
P5-01	Relay Output Function Selection (TA2-TB2-TC2)	0: no output 1: inverter operation 2: fault output (for free shutdown fault) 3: frequency level detection FDT 1 output 4: frequency reached 5: zero speed operation (shutdown without output) 6: motor overload forecast alarm 7: inverter overload forecast alarm 8: setting value to 9: specified value reached 10: length to 11: PLC cycle complete 12: cumulative running time to 13: frequency limit 14: torque limit in 15: running ready 16: AI1> AI2 17: upper limit frequency reached 18: lower limit frequency reached (running) 19: undervoltage state output 20: communication set 21: positioning complete (keep) 22: positioning close (keep) 23:2 in zero speed operation (also output) 24: cumulative power time reached 25: frequency level detection FDT 2 output 26: frequency 1 reach output 27: frequency 2 reach output 28: current 1 reach output 29: current 2 reach output 30: timing reached output 31: AI1 input exceeded 32: drop load medium 33: reverse operation 34: zero current state 35: module temperature reached 36: output current exceeded 37: lower frequency reached (shutdown also output) 38: alarm output (all faults) 39: Motor overtemperature forecast alarm 40: the operation time reaches 41: non-undervoltage fault output (free shutdown fault)	0	☆
P5-02	Control Board Relay Function Selection (TA1-TB1-TC1)		2	☆
P5-03	Relay output function selection (TA3-TB3-TC3)		0	☆
P5-04	DO 1 output function selection		1	☆
P5-05	Expansion card DO 2 output selection		4	☆
P5-06	The FMP output function selection	0: Operating frequency 1: set frequency 2: Output current 3: Output torque (absolute torque value) 4: output power 5: Output voltage 6: PULSE input (100.0% corresponds to 100.0kHz) 7: AI1 8: AI2 9: AI3 (expansion card) 10: Length 11: Note value 12: Communication setting 13: Motor Speed 14: Output current (100.0% corresponds to 1000.0A) 15: Output voltage (100.0% corresponds to 1000.0V) 16: Output torque (actual torque value)	0	☆
P5-07	AO1Output function selection		0	☆
P5-08	AO2 output function selection		1	☆
P5-09	FMP output the	0.01kHz~100.00kHz	50.00kHz	☆

	maximum frequency		z	
P5-10	AO1 zero-bias coefficient	-100.0%~+100.0%	0.0%	☆
P5-11	AO1 gain	-10.00~+10.00	1.00	☆
P5-12	AO2 zero-bias coefficient	-100.0%~+100.0%	0.0%	☆
P5-13	AO2 gain	-10.00~+10.00	1.00	☆
P5-17	PMR output delay time	0.0s~3600.0s	0.0s	☆
P5-18	TA1-TB1-TC1 output delay time	0.0s~3600.0s	0.0s	☆
P5-19	TA2-TB2-TC2 output delay time	0.0s~3600.0s	0.0s	☆
P5-20	DO 1 output delay time	0.0s~3600.0s	0.0s	☆
P5-21	DO 2 output delay time	0.0s~3600.0s	0.0s	☆
P5-22	DO output terminal valid state selection	0: Positive logic 1: reverse logic individual bit: FMR Ten place: TA1-TB1-TC1 100 bits: TA3-TB3-TC3 Thousand digits: DO 1 (TA2-TB2-TC2) Ten thousand digits: DO 2	00000	☆

P6 group start-stop control

P6-00	Starting mode	0: Direct start 1: Speed tracking and restarting 2: Pre-excitation start (AC asynchronous machine) 3: SVC quick startup	0	☆
P6-01	Speed tracking method	0: Start from the shutdown frequency 1: Start at zero speed 2: Start at the maximum frequency 3: Current frequency start, can detect the motor direction, V / F Control effective	0	★
P6-02	Speed tracking fast and slow	1~100	20	☆
P6-03	Start frequency	0.00Hz~10.00Hz	0.00Hz	☆
P6-04	Start the frequency hold time	0.0s~100.0s	0.0s	★
P6-05	Start the DC brake current / pre-excitation current	0%~100%	0%	★
P6-06	Start the DC braking time / preexcitation time	0.0s~100.0s	0.0s	★
P6-07	Add deceleration mode	0: linear acceleration and deceleration 1: S-curve acceleration and deceleration A 2: S-curve acceleration and deceleration B	0	★
P6-08	S curve start period time scale	0.0%~ (100.0%-P6-09)	30.0%	★
P6-09	S curve end period time scale	0.0%~ (100.0%-P6-08)	30.0%	★
P6-10	Downtime method	0: Slow down and stop. 1: Free parking	0	☆

P6-11	Stop time DC brake starting frequency	0.00Hz~ the maximum frequency	0.00Hz	☆
P6-12	Shutdown for the DC brake waiting time	0.0s~100.0s	0.0s	☆
P6-13	Shutdown DC brake current	0%~100%	0%	☆
P6-14	Stop the DC brake time	0.0s~100.0s	0.0s	☆
P6-15	Brake utilization rate	0%~100%	100%	☆
P6-16	Brake resistance voltage opening point	200.0~2000.0V	Model determination	☆
P6-18	Speed tracking current size	30%~200%	Model determination	★
P6-21	Demagnetization time (SVC is valid)	0.00~5.00s	Model determination	☆
P6-23	Excessive excitation selection	0: Not effective 1: deceleration only 2: Effective throughout the whole process	0	☆
P6-24	Overexcitation suppression current value	0~150%	100%	☆
P6-25	Overexcitation gain	1.00~2.50	1.25	☆
P7 group keyboard and display				
P7-00	Keep back	0	0	●
P7-01	JOG/QUICKKey function selection	0: Menu mode switching 1: Operation panel command channel and remote command channel (Terminal command channel or communication command channel) switch 2: Forward and reverse switch 3: Positive point movement 4: Reverse point movement	0	★
P7-02	STOP / RESET key function	0: STOP / RESET key shutdown function on keyboard operation only 1: The STOP / RESET key shutdown function works in any operation mode	1	☆

P7-03	LED run display parameter 1	0000~FFFF Bit 00: Operating Frequency 1 (Hz) Bit 01: Set Frequency (Hz) Bit 02: Bus Voltage (V) Bit 03: Output Voltage (V) Bit 04: Output Current (A) Bit 05: Output Power (kW) Bit 06: Output Torque (%) Bit 07: DI Input State Bit 08: DO Output State Bit 09: AI1 Voltage (V) Bit 10: AI2 Voltage (V) Bit 11: AI3 Voltage (V) Bit 12: Count value Bit 13: Length value Bit 14: with the load speed display Bit 15: PID setting	1F	☆
P7-04	LED run display parameter 2	0000~FFFF Bit 00: PID Feedback Bit 01: PLC stage Bit 02: PULSE Input pulse frequency (kHz) Bit 03: Operating frequency 2 (Hz) Bit 04: Remaining Run Time Bit 05: AI1 front voltage (V) Bit 06: AI2 front voltage (V) Bit 07: AI3 front voltage (V) Bit 08: linear speed Bit 09: Current Power Up Time (Hour) Bit 10: Current Run Time (Min) Bit 11: PULSE Input pulse frequency (Hz) Bit 12: Communication Setpoint Bit 13: Encoder feedback speed (Hz) Bit 14: Main frequency X Display (Hz) Bit 15: Secondary Frequency Y display (Hz)	0	☆
P7-05	LED shutdown to display the parameters	0000~FFFF Bit 00: Set Frequency (Hz) Bit 01: Bus Voltage (V) Bit 02: DI Input State Bit 03: DO Output State Bit 04: AI1 Voltage (V) Bit 05: AI2 Voltage (V) Bit 06: AI3 Voltage (V) Bit 07: Count value Bit 08: Length value Bit 09: PLC stage Bit 10: Load speed Bit 11: PID setting Bit 12: PULSE input pulse frequency (kHz)	33	☆
P7-06	Load speed display coefficient	0.0001~6.5000	1.0000	☆

P7-07	Inverter module, the radiator temperature	0.0°C~100.0°C	-	●
P7-08	Recfier bridge radiator temperature	0.0°C~100.0°C	-	●

P7-09	Cumulative running time	0h~65535h	-	●
P7-10	Product number	-	-	●
P7-11	Software version number	-	-	●
P7-12	Load speed shows the decimal number	20:0 decimal place 21:1 decimal place 22:2 decimal place 23:3 decimal place	21	☆
P7-13	Cumulative power time	0h~65535h	-	●
P7-14	Accumulated power consumption	0 kW to 65535 degrees	-	●
P7-17	Second row LED display parameters	0~6 0: Operating frequency of 1 (Hz) 1: Set Frequency (Hz) 2: Bus bar voltage (V) 3: Output voltage (V) 4: Output current (A) 5: Output power (kW) 6: Output torque: (%)	0	☆
P8 group of auxiliary function parameters				
P8-00	Point movement operation frequency	0.00Hz~ the maximum frequency	2.00Hz	☆
P8-01	Point motion acceleration time	0.0s~6500.0s	20.0s	☆
P8-02	Point motion deceleration time	0.0s~6500.0s	20.0s	☆
P8-03	Acceleration time 2	0.0s~6500.0s	Model determination	☆
P8-04	Slow down time 2	0.0s~6500.0s	Model determination	☆
P8-05	Acceleration time 3	0.0s~6500.0s	Model determination	☆
P8-06	Slow down time 3	0.0s~6500.0s	Model determination	☆
P8-07	Acceleration time 4	0.0s~6500.0s	Model determination	☆
P8-08	Slow down time 4	0.0s~6500.0s	Model determination	☆
P8-09	Jump frequency 1	0.00Hz~ the maximum frequency	0.00Hz	☆
P8-10	Jump frequency 2	0.00Hz~ the maximum frequency	0.00Hz	☆
P8-11	Jump frequency amplitude	0.00Hz~ the maximum frequency	0.00Hz	☆

P8-12	Forward and reverse dead zone time	0.0s~3000.0s	0.0s	☆
P8-13	Reverse control enabling	0: Allow 1: prohibited	0	☆
P8-14	Set the frequency below the lower limit frequency operating mode	0: Run at the lower limit frequency 1: Downtime 2: Zero speed operation	0	☆
P8-15	Drop control	0.00Hz~10.00Hz	0.00Hz	☆
P8-16	Set the cumulative power arrival time	0h~65000h	0h	☆
P8-17	Sets the cumulative run arrival time Between	0h~65000h	0h	☆
P8-18	Start protection options	0: no protection; 1: protection	0	☆
P8-19	Frequency detection value (FDT 1)	0.00Hz~ the maximum frequency	50.00Hz	☆
P8-20	Frequency detection lag value (FDT1)	0.0%~100.0% (FDT 1 level)	5.0%	☆
P8-21	Frequency reaches the detected width	0.0%~100.0% (maximum frequency)	0.0%	☆
P8-22	Whether the jump frequency is effective during the acceleration and deceleration process	0: Invalid 1: valid	0 0	☆
P8-25	Acceleration time 1 versus acceleration time 2 Switch frequency points	0.00Hz~ the maximum frequency	0.00Hz	☆
P8-26	Reduced down time 1 and the deceleration time 2 Switch frequency points	0.00Hz~ the maximum frequency	0.00Hz	☆
P8-27	Terminal point motion is preferred	0: Invalid 1: valid	0	☆
P8-28	Frequency detection value (FDT 2)	0.00Hz~ the maximum frequency	50.00Hz	☆
P8-29	Frequency detection lag value (FDT2)	0.0%~100.0% (FDT 2 level)	5.0%	☆
P8-30	Arbitrary arrival frequency detection value of 1	0.00Hz~ the maximum frequency	50.00Hz	☆
P8-31	The width is detected at any arrival frequency Degree 1	0.0%~100.0% (maximum frequency)	0.0%	☆
P8-32	Arbitrary arrival frequency detection value of 2	0.00Hz~ the maximum frequency	50.00Hz	☆
P8-33	The width is detected at any arrival frequency Degree 2	0.0%~100.0% (maximum frequency)	0.0%	☆
P8-34	Zero-current detection level	0.0%~300.0% 100.0% corresponds to the motor rated current	5.0%	☆
P8-35	Zero-current detection delay time	0.01s~600.00s	0.10s	☆

P8-36	Output current exceeds the limit value	0.0% (not tested) 0.1%~300.0% (rated current of the motor)	200.0%	☆
P8-37	Output current overlimit detection delay Late time	0.00s~600.00s	0.00s	☆
P8-38	Arbitrary arrival current of 1	0.0%~300.0% (rated current of the motor)	100.0%	☆
P8-39	Any reach current 1 width	0.0%~300.0% (rated current of the motor)	0.0%	☆
P8-40	Arbitrary arrival current of 2	0.0%~300.0% (rated current of the motor)	100.0%	☆
P8-41	Any reach current 2 width	0.0%~300.0% (rated current of the motor)	0.0%	☆
P8-42	Time function selection	0: Invalid 1: valid	0	★
P8-43	Timed running time selection	0: P8-44 setting 1: AI1 2: AI2 3: AI3 The simulated input range corresponds to P8-44	0	★
P8-44	Time running time	0.0Min~6500.0Min	0.0Min	★
P8-45	Lower AI1 input voltage protection value limit	0.00V~P8-46	3.10V	☆
P8-46	AI1 input voltage protection value limit	P8-45~11.00V	6.80V	☆
P8-47	Module temperature arrives	0℃~100℃	75℃	☆
P8-48	Heat dissipation fan control	0: Fan is running during operation 1: Fan is always running When the temperature exceeds 40 degrees, the shutdown state fan continues to operate	0	★
P8-53	The arrival time of this operation is set fix	0.0Min~6500.0Min	0.0Min	★
P8-54	Output power correction coefficient	0.00% ~ 200.0%	100.0%	☆
P8-55	Emergency stop deceleration time	0 ~ 6553.5	Model determination	☆
P9 group failure and protection				
P9-00	Motor overload protection selection	0: Ban 1: allow	1	☆
P9-01	Motor overload protection gain	0.20~10.00	1.00	☆
P9-02	Motor overload warning factor	50%~100%	80%	☆
P9-03	Overpressure stall gain	0~100	30	☆
P9-04	Over-voltage stall protection voltage	636~795	760	★
P9-05	Overloss speed gain	0~100	20	☆
P9-06	Over-drain speed protection current	100%~200%	150%	★
P9-07	Power on to ground short circuit protection selection select	0: Invalid 1: valid	1	☆

P9-08	Multiple fold limiting coefficient of V / F weak magnetic zone	50%~300%	200%	★
P9-09	Number of automatic reset	0~20	0	☆
P9-10	Fault DO action selection during fault automatic reset	0: Do not move 1: Action	0	☆
P9-11	When the fault automatic reset interval Between	0.1s~100.0s	1.0s	☆
P9-12	Enter the missing phase-protection selection	0: Ban 1: allow	1	☆
P9-13	Output the missing phase protection selection	0: Ban 1: allow	1	☆
P9-14	First-time fault type	0: No fault 1: Keep	—	●
P9-15	The second failure type	2: Accelerated overcurrent 3: decelerated overcurrent 4: constant speed over current 5: accelerated overvoltage 6: deceleration overvoltage 7: constant speed overvoltage 8: Buffered resistance to overload 9: Underpressure 10: Drive overload 11: Motor overload 12: Enter the missing phase 13: Output is in-phase deficiency 14: The module is overheated 15: External failure 16: Communication is abnormal 17: Conactor abnormal 18: abnormal current detection 19: Abnormal motor tuning 20: Encoder / PG card is abnormal 21: abnormal parameter reading and writing 22: Drive hardware is abnormal 23: Motor is short-circuit to the ground 24: Keep 25: Keep 26: Run time arrives 27: User-defined fault 1 28: User-defined fault 2 29: Power-up on the time to arrive 30: Loading 31: The PID feedback is lost during the runtime 40: Fast current limit timeout 41: Switch the motor during operation 42: Excessive speed deviation 43: Motor overspeed 45: Motor over-temperature	—	●
P9-16	Third (most recent) failure type		—	●
P9-17	Third time (most recent) reason Frequency of barriers	—	—	●
P9-18	Current at the third (latest) failure	—	—	●
P9-19	Third time (most recent) Bus voltage at failure	—	—	●

P9-20	Third time (last time), enter the terminal status during the failure	—	—	•
P9-21	Third time (most recent) Output terminal status during the failure	—	—	•
P9-22	Drive status at the third (latest) failure	—	—	•
P9-23	Third time (most recent) Power time during failure	—	—	•
P9-24	Run time for the third (latest) failure	—	—	•
P9-27	Frequency during the second failure	—	—	•
P9-28	Current	—	—	•
P9-29	Bus voltage at the second failure	—	—	•
P9-30	Enter the terminal status at the second fault	—	—	•
P9-31	Output terminal status at the second failure	—	—	•
P9-32	Drive status at the second failure	—	—	•
P9-33	Power-on time during the second failure	—	—	•
P9-34	Run time for the second failure time	—	—	•
P9-37	Frequency at the first failure	—	—	•
P9-38	Current at the first fault	—	—	•
P9-39	Bus voltage at the first failure	—	—	•
P9-40	Enter the terminal status at the first failure	—	—	•
P9-41	Output terminal status at the first failure	—	—	•
P9-42	Drive status at the first failure	—	—	•
P9-43	Power time during the first failure	—	—	•
P9-44	Run time during the first failure	—	—	•
P9-47	Fault protection action selection 1	Individual bit: motor overload (11) 0: Free parking 1: Stop by shutdown mode 2: Continue running Ten places: input phase absence (12) hundred bits: output phase absence (13) thousand bits: external fault (15) ten thousand bits: communication exception (16)	00000	☆

P9-48	Fault protection action selection 2	Individual bit: Encoder / PG card exception (20) 0: Free parking Ten place: abnormal reading and writing of functional code (21)	00000	☆
		0: Free parking 1: according to the shutdown mode, the shutdown of 100 bits: reserved Thousand: motor overheating (25) Million: running time reached (26)		
P9-49	Fault protection action selection 3	Individual bit: user-defined fault 1 (27) 0: Free parking 1: Stop by shutdown mode 2: Continue running Ten place: User-defined fault 2 (28) 0: Free parking 1: Stop by shutdown mode 2: Continue running Hundred: Power time arrival (29) 0: Free parking 1: Stop by shutdown mode 2: Continue running Thousand bits: drop load (30) 0: Free parking 1: Slow down and stop 2: Reduce speed to 7% of the rated frequency of the motor, and automatically return to the set frequency operation: PID feedback loss during operation (31) 0: Free parking 1: Stop by shutdown mode 2: Continue running	00000	☆
P9-50	Fault protection action selection 4	Individual bit: excessive speed deviation (42) 0: Free parking 1: Stop by shutdown 2: Continue running Ten digits: motor overspeed (43) 100 bits: initial position error (51)	00000	☆
P9-54	Continue running frequency selection when failure	0: Run at the current operating frequency 1: Run at a set frequency 2: Above limit frequency operation 3: Run at the lower limit frequency 4: Run at an abnormal standby frequency	0	☆
P9-55	Abnormal backup frequency	60.0%~100.0%	100.0%	☆
P9-56	Motor temperature sensor type	0: No temperature sensor 1: PT100 2: PT1000	0	☆
P9-57	Motor overheat protection threshold	0℃~200℃	110℃	☆
P9-58	Motor overheating forecast alarm threshold	0℃~200℃	90℃	☆
P9-59	Selection of instantaneous power outage action	0: invalid 1: Slow down 2: Slow down	0	★
P9-60	Insient stop action stops the judgment voltage	80.0%~100.0%	85.0%	★

P9-61	Instantaneous power outage voltage recovery judgment Break time	0.00s~100.00s	0.50s	★
P9-62	Instantaneous power failure action judgment power press	60.0%~100.0% (standard bus bar voltage)	80.0%	★
P9-63	Loading protection options	0: invalid 1: valid	0	☆
P9-64	Desload detection level	0.0~100.0%	10.0%	☆
P9-65	Deload detection time	0.0~60.0s	1.0s	☆
P9-67	Overspeed detection value	0.0% to 50.0% (Maximum frequency)	20.0%	☆
P9-68	Overspeed detection time	0.0s~60.0s	1.0s	☆
P9-69	Excessive velocity deviation and the detection value	0.0% to 50.0% (Maximum frequency)	20.0%	☆
P9-70	The velocity deviation is too large for the detection time	0.0s~60.0s	5.0s	☆
P9-71	Instant stop gain Kp	0~100	40	☆
P9-72	The-stop integral coefficient Ki	0~100	30	☆
P9-73	Instant stop stop deceleration time	0~300.0s	20.0s	★
P9-74	V / F overpressure suppresses the rising frequency	5Hz~50Hz	5Hz	★
PID function in the PA group				
PA-00	PID for a given source	0: PA-01 setting 1: AI1 2: AI2 3: AI3 4: PULSE Pulse setting (DI5) 5: Communication given 6: Multiple instructions are given	0	☆
PA-01	The PID values are given	0.0%~100.0%	50.0%	☆
PA-02	PID feedback source	0: AI1 1: AI2 2: AI3 3: AI1-AI2 4: PULSE Pulse setting (DI5) 5: Communication given6: AI1+AI2 7: MAX (AI1 , AI2) 8: MIN (AI1 , AI2)	0	☆
PA-03	PID application direction	0: Positive effect 1: Counteraction	0	☆
PA-04	PID given the feedback range	0~1000	100	☆
PA-05	Proportional gain of Kp 1	0.0~100.0	20.0	☆

PA-06	Integral time, Ti1	0.01s~10.00s	2.00s	☆
PA-07	Differential time, Td 1	0.000s~10.000s	0.000s	☆
PA-08	PID reversal cutoff frequency	0.00 to the maximum frequency	0.00Hz	☆
PA-09	PID deviation limit	0.0%~100.0%	0.0%	☆
PA-10	PID differential limit amplitude	0.00%~100.00%	0.10%	☆
PA-11	PID given the time of change	0.00~650.00s	0.00s	☆
PA-12	PID feedback filtering time	0.00~60.00s	0.00s	☆
PA-13	PID output filter time	0.00~60.00s	0.00s	☆
PA-14	Keep back	-	-	☆
PA-15	Proportional gain of Kp 2	0.0~100.0	20.0	☆
PA-16	Integral time, Ti2	0.01s~10.00s	2.00s	☆
PA-17	Differential time, Td 2	0.000s~10.000s	0.000s	☆
PA-18	PID parameter switching conditions	0: Don't switch 1: Switch through the DI terminal 2: Automatic switch according to the deviation	0	☆
PA-19	PID parameter switching deviation 1	0.0%~PA-20	20.0%	☆
PA-20	PID parameter switching deviation 2	PA-19~100.0%	80.0%	☆
PA-21	PID starter	0.0%~100.0%	0.0%	☆
PA-22	PID initial value holding time	0.00~650.00s	0.00s	☆
PA-23	Two output deviation positive maximum value	0.00%~100.00%	1.00%	☆
PA-24	Two output deviation reverse maximum	0.00%~100.00%	1.00%	☆
PA-25	PID integration attribute	Individual bit: integral separation 0: invalid 1: valid Ten place: stop integration after output to the limit 0: Continue the points 1: Stop points	00	☆
PA-26	PID feedback loss detection value	0.0%: not judging the feedback loss 0.1%~100.0%	0.0%	☆
PA-27	When the PID feedback loss is detected Between	0.0s~20.0s	0.0s	☆
PA-28	PID shutdown operation	0: Stop without operation 1: Operation during shutdown	0	☆
Pulum frequency, fixed length and count in Pb group				
Pb-00	Setting mode of pendulum frequency	0: relative to the center frequency 1: Relative to the maximum frequency	0	☆
Pb-01	Frequency amplitude	0.0%~100.0%	0.0%	☆

Pb-02	Amplitude of the jump frequency	0.0%~50.0%	0.0%	☆
Pb-03	Pop frequency cycle	0.1s~3000.0s	10.0s	☆
Pb-04	When the triangular wave of the swing frequency rises Between	0.1%~100.0%	50.0%	☆
Pb-05	Set the length	0m~65535m	1000m	☆
Pb-06	Physical length	0m~65535m	0m	☆
Pb-07	Pulse number per meter	0.1~6553.5	100.0	☆
Pb-08	Set the gauge value	1~65535	1000	☆
Pb-09	Specify the count value	1~65535	1000	☆
PC group of multiple instructions, simple PLC				
PC-00	Multiparagraph instruction 0	-100.0%~100.0%	0.0%	☆
PC-01	Multiparagraph instruction 1	-100.0%~100.0%	0.0%	☆
PC-02	Multiparagraph instruction 2	-100.0%~100.0%	0.0%	☆
PC-03	Multiparagraph instruction 3	-100.0%~100.0%	0.0%	☆
PC-04	Multiparagraph instruction 4	-100.0%~100.0%	0.0%	☆
PC-05	Multiparagraph instruction 5	-100.0%~100.0%	0.0%	☆
PC-06	Multiparagraph instruction 6	-100.0%~100.0%	0.0%	☆
PC-07	Multiparagraph instruction 7	-100.0%~100.0%	0.0%	☆
PC-08	Multiparagraph instruction 8	-100.0%~100.0%	0.0%	☆
PC-09	Multiparagraph instruction 9	-100.0%~100.0%	0.0%	☆
PC-10	Multiparagraph instruction 10	-100.0%~100.0%	0.0%	☆
PC-11	Multiparagraph instruction 11	-100.0%~100.0%	0.0%	☆
PC-12	Multiparagraph instruction 12	-100.0%~100.0%	0.0%	☆
PC-13	Multiparagraph instruction 13	-100.0%~100.0%	0.0%	☆
PC-14	Multiparagraph instruction 14	-100.0%~100.0%	0.0%	☆
PC-15	Multiparagraph instruction 15	-100.0%~100.0%	0.0%	☆
PC-16	Multiparagraph instruction 0	0: Stop after a single operation 1: Maintain the final value at the end of a single run 2: Always cycle	0	☆

PC-17	Simple PLC power memory selection	One bit: power loss memory selection 0: Power loss without memory 1: ELECTRIC memory Ten-place: shutdown memory selection 0: Stop without memory 1: Stop memory	00	☆
PC-18	Easy PLC paragraph 0 runtime Between	0.0s (h) ~6500.0s (h)	0.0s (h)	☆
PC-19	Simple PLC in paragraph 0	0~3	0	☆
PC-20	Easy PLC paragraph 1 run time	0.0s (h) ~6500.0s (h)	0.0s (h)	☆
PC-21	Paragraph 1 of acceleration and deceleration time selection of simple PLC	0~3	0	☆
PC-22	Easy PLC paragraph 2 run time	0.0s (h) ~6500.0s (h)	0.0s (h)	☆
PC-23	Simple PLC paragraph 2 acceleration and deceleration time selection	0~3	0	☆
PC-24	Simple PLC paragraph 3 run time	0.0s (h) ~6500.0s (h)	0.0s (h)	☆
PC-25	Simple PLC paragraph 3 of acceleration and deceleration time selection	0~3	0	☆
PC-26	Simple PLC paragraph 4 run time	0.0s (h) ~6500.0s (h)	0.0s (h)	☆
PC-27	Selection of the acceleration and deceleration time of the simple PLC in paragraph 4	0~3	0	☆
PC-28	Easy PLC paragraph 5 run time	0.0s (h) ~6500.0s (h)	0.0s (h)	☆
PC-29	Simple PLC paragraph 5 selection of acceleration and deceleration time	0~3	0	☆
PC-30	Simple PLC paragraph 6 run time	0.0s (h) ~6500.0s (h)	0.0s (h)	☆
PC-31	Paragraph 6 of acceleration and deceleration time selection of simple PLC	0~3	0	☆
PC-32	Simple PLC paragraph 7 run time	0.0s (h) ~6500.0s (h)	0.0s (h)	☆
PC-33	Paragraph 7 of acceleration and deceleration time selection of simple PLC	0~3	0	☆
PC-34	Simple PLC paragraph 8 run time	0.0s (h) ~6500.0s (h)	0.0s (h)	☆

PC-35	Paragraph 8 of selection of simple PLC	0~3	0	☆
PC-36	Simple PLC paragraph 9 run time	0.0s (h) ~6500.0s (h)	0.0s (h)	☆
PC-37	Simple PLC segment 9 of acceleration and deceleration time selection	0~3	0	☆
PC-38	Easy PLC paragraph 10 run time	0.0s (h) ~6500.0s (h)	0.0s (h)	☆
PC-39	Add and subtract in paragraph 10 of the simple PLC Speed time selection	0~3	0	☆
PC-40	Easy PLC paragraph 11 run time	0.0s (h) ~6500.0s (h)	0.0s (h)	☆
PC-41	Paragraph 11 of the simple PLC Speed time selection	0~3	0	☆
PC-42	Simple PLC paragraph 12 run time	0.0s (h) ~6500.0s (h)	0.0s (h)	☆
PC-43	Add and subtract in paragraph 12 of the simple PLC Speed time selection	0~3	0	☆
PC-44	Simple PLC paragraph 13 run time	0.0s (h) ~6500.0s (h)	0.0s (h)	☆
PC-45	Add and subtract in paragraph 13 of the simple PLC Speed time selection	0~3	0	☆
PC-46	Simple PLC paragraph 14 run time	0.0s (h) ~6500.0s (h)	0.0s (h)	☆
PC-47	Add and subtract in paragraph 14 of the simple PLC Speed time selection	0~3	0	☆
PC-48	Simple PLC paragraph 15 run time	0.0s (h) ~6500.0s (h)	0.0s (h)	☆
PC-49	Add and subtract in paragraph 15 of the simple PLC Speed time selection	0~3	0	☆
PC-50	Simple PLC running time unit	0: s (seconds) 1: h (hours)	0	☆
PC-51	Multi-paragraph instruction 0 given way	0: Function code PC-00 is given 1: AI1 2: AI2 3: AI3 4: The PULSE pulse 5: PID 6: preset frequency (P0-08), UP / DOWN can be modified	0	☆

The Pd group communication parameters

Pd-00	Baud rate	Individual bit: MODBUS 0:300 BPS 1: 600BPS 2: 1200BPS 3: 2400BPS 4: 4800BPS 5: 9600BPS 6: 19200BPS 7: 38400BPS 8: 57600BPS 9: 115200BPS Ten place: ProPibus-DP 0:115200 BPs 1: 208300BPs 2: 256000BPs 3: 512000Bps 100 Positions: Keep Thousand bits: CANlink baud rate 0: 20	5005	☆
		1: 50 2: 100 3: 125 4: 250 5: 500 6: 1M		
Pd-01	Data format	0: No check (8-N-2) 1: even check (8-E-1) 2: odd check (8-O-1) 3: 8-N-1	0	☆
Pd-02	This machine address	1~247,0 is for the broadcast address	1	☆
Pd-03	Answering delay	0ms~20ms	2	☆
Pd-04	Communication timeout time	0.0 (invalid), 0.1s~60.0s	0.0	☆
Pd-05	Data transfer format selection	Individual bit: MODBUS 0: Non-standard MODBUS protocol 1: Standard MODBUS protocol ten place: ProPibus-DP 0: PFO 1 format 1: It is used in the PFO 2 format 2: PFO 3 format 3: It is used in the PFO 5 format	31	☆
Pd-06	Communication to read the current resolution	0: 0.01A 1: 0.1A	0	☆
Pd-08	Canlink Communication timeout time	0.0s: Invalid 0.1~60.0s	0	☆
PE group user custom function code				
PE-00	User function code 0		P0.10	☆
PE-01	User function code 1		P0.02	☆
PE-02	User function code 2		P0.03	☆
PE-03	User function code 3		P0.07	☆
PE-04	User function code 4		P0.08	☆

PE-05	User function code 5	P0-00~PP-xx H0-00~Ax-xx U0-xx~U0-xx	P0.17	☆
PE-06	User function code 6		P0.18	☆
PE-07	User function code 7		P3.00	☆
PE-08	User function code 8		P3.01	☆
PE-09	User function code 9		P4.00	☆
PE-10	User function code 10		P4.01	☆
PE-11	User function code 11		P4.02	☆
PE-12	User function code 12		P5.04	☆
PE-13	User function code 13		P5.07	☆
PE-14	User function code 14		P6.00	☆
PE-15	User function code 15		P6.10	☆
PE-16	User function code 16		P0.00	☆
PE-17	User function code 17		P0.00	☆
PE-18	User function code 18		P0.00	☆
PE-19	User function code 19	P0.00	☆	
PE-20	User function code 20	P0.00	☆	
PE-21	User function code 21	P0.00	☆	
PE-22	User function code 22	P0.00	☆	
PE-23	User function code 23	P0.00	☆	
PE-24	User function code 24	P0.00	☆	
PE-25	User function code 25	P0.00	☆	
PE-26	User function code 26	P0.00	☆	
PE-27	User function code 27	P0.00	☆	
PE-28	User function code 28	P0.00	☆	
PE-29	User function code 29	P0.00	☆	
PP group function code management				
PP-00	User password	0~65535	0	☆
PP-01	Parameter initialization	0: No operation 01: Restore the factory parameters, excluding the motor parameters 02: Clear the record information 04: Restore the user backup parameters 501: Backup user current parameter	0	★

PP-02	Functional parameter group display selection	Individual bit: U group display selection 0: Do not show 1: Show Ten place: Group A display selection 0: Do not show 1: Show	11	★
PP-03	Personality parameter group display selection	Individual bit: User-customized parameter group display selection 0: Do not show 1: Show Ten place: User change parameter group display selection 0: Do not show 1: Show	00	☆
PP-04	Function code modifies the properties	0: Modifiable 1: Unmodifiable	0	☆
PP-05	Model setting	1: G type machine 2: P type machine	1	★
H0 group of torque control parameters				
H0-00	Selection of the speed / torque control mode	0: Speed control 1: Torque control	0	★
H0-01	Torque control mode under the torque setting source selection	0: Digital setting 1 (H0-03) 1: AI1 2: AI2 3: AI3 4: The PULSE pulse 5: Communication given 6: MIN (AI1, AI2) 7: MAX (AI1, AI2) (full range of option 1-7, corresponding to H0-03 number setting)	0	★
H0-03	Torque number setting under the torque control mode	-200.0%~200.0%	150.0%	☆
H0-05	Torque control forward maximum frequency rate	0.00Hz~ the maximum frequency	50.00Hz	☆
H0-06	Torque control reverse maximum frequency	0.00Hz~ the maximum frequency	50.00Hz	☆
H0-07	Torque to control the acceleration time	0.00s~650s	0.00s	☆
H0-08	Torque-controlled deceleration time	0.00s~650s	0.00s	☆
H1 group of virtual IO				
H1-00	Virtual VDI 1 terminal function	0~59	0	★
H1-01	Virtual VDI 2 terminal function	0~59	0	★
H1-02	Virtual VDI 3 terminal function	0~59	0	★
H1-03	Virtual VDI 4 terminal function	0~59	0	★
H1-04	Virtual VDI 5 terminal function	0~59	0	★

H1-05	Virtual VDI terminal state setting mode	0: The validity of the VS is determined by the status of the virtual VDOx 1: Set VS is set by function code H1-06: virtual VDI 1 Ten places: virtual VDI 2,100 bits: virtual VDI 3 Thousand bits: virtual VDI 40,000 bit: virtual VDI 5	00000	★
H1-06	Virtual VDI terminal state setting	0: invalid 1: valid One: virtual VDI 1 ten: virtual VDI 2 hundred: virtual VDI 3 Thousand bits: virtual VDI 40,000 bit: virtual VDI 5	00000	★
H1-08	Functional selection of the AI2 terminal as a digital input terminal	0~59	0	★
H1-09	Functional selection of the AI3 terminal as a digital input terminal	0~59	0	★
H1-10	Effectivemode selectionfor analog	0: high level 1: Low level effective single bit: AI1 Ten: AI2 100: AI3	000	★
H1-11	Virtual VDO 1 output function selection	0: internal ted with physical Sx 1~40: See P5 Group Physical DO output selection	0	☆
H1-12	Virtual VDO 2 output function selection	0: internal ted with physical Sx 1~40: See P5 Group Physical DO output selection	0	☆
H1-13	Virtual VDO 3 output function selection	0: internal ted with physical Sx		☆
		1~40: See P5 Group Physical DO output selection	0	
H1-14	Virtual VDO 4 output function selection select	0: internal ted with physical Sx 1~40: See P5 Group Physical DO output selection	0	☆
H1-15	Virtual VDO 5 output function selection	0: internal ted with physical Sx 1~40: See P5 Group Physical DO output selection	0	☆
H1-16	VDO 1 output delay time	0.0s~3600.0s	0.0s	☆
H1-17	VDO 2 output delay time	0.0s~3600.0s	0.0s	☆
H1-18	VDO 3 output delay time	0.0s~3600.0s	0.0s	☆
H1-19	VDO 4 output delay time	0.0s~3600.0s	0.0s	☆

H1-20	VDO 5 output delay time	0.0s~3600.0s	0.0s	☆
H1-21	VDO output terminal has a valid state selection	0: Positive logic 1: reverse logic single bit: VDO 1 ten: VDO 2100: VDO 3 Thousand digits: VDO 40,000 digits: VDO 5	00000	☆
H2 group second motor control				
H2-00	Motor type selection	0: Ordinary Asynchronous motor 1: variable frequency induction motor	0	★
H2-01	Motor is rated power	0.1kW~1000.0kW	Model determination	★
H2-02	Motor is rated voltage	1V~2000V	Model determination	★
H2-03	Rated current of motor	0.01A~655.35A (Drive power <=55kW) 0.1A~6553.5A (Drive power> 55kW)	Model determination	★
H2-04	Rated frequency of motor	0.01Hz~ the maximum frequency	Model determination	★
H2-05	Motor rated speed	1rpm~65535rpm	Model determination	★
H2-06	Asynchronous motor stator resistance	0.001 Ω ~65.535 Ω (drive power <=55kW) 0.0001 Ω ~6.5535 Ω (Drive power> 55kW)	Model determination	★
H2-07	Asynchronous motor rotor resistance	0.001 Ω ~65.535 Ω (drive power <=55kW) 0.0001 Ω ~6.5535 Ω (Drive power> 55kW)	Model determination	★
H2-08	Leakage resistance of Asynchronous motor	0.01 mH ~ 655.35mH (drive power <=55kW) 0.001 mH ~ 65.535mH (Drive power> 55kW)	Model determination	★
H2-09	Mutual inductive resistance of Asynchronous motor	0.01 mH ~ 655.35mH (drive power <=55kW) 0.001 mH ~ 65.535mH (Drive power> 55kW)		★
H2-10	No-load current of Asynchronous motor	0.01A~H2-03 (Drive power <=55kW) 0.1A~H2-03 (Drive power> 55kW)	Model determination	★
H2-27	Number of encoder lines	1~65535	1024	★
H2-28	Encoder type	0: The ABZ incremental encoder 1: The UVW incremental encoder 2: Rotary transformer 3: A scosine encoder 4: Provincial line mode UVW encoder	0	★
H2-29	Speed to give	0: Local PG 1: Extended PG	0	★

	feedback to the PG selection	2: PULSE Pulse input (DI5)		
H2-30	ABZ Incremental encoder AB phase order	0: Positive 1: Reverse	0	★
H2-31	Encoder installation angle	0.0~359.9°	0.0°	★
H2-32	UVW encoder is the UVW phase order	0: Positive 1: Reverse	0	★
H2-33	UVW encoder bias angle	0.0~359.9°	0.0°	★
H2-34	Rotary transformer pole-log	1~65535	1	★
H2-36	Speed feedback PG break detection time	0.0: No action 0.1s~10.0s	0.0	★
H2-37	Tune selection	0: No operation 1: asynchronous machine static tuning 2: Complete tuning of asynchronous 3: Aynnof static static complete machine	0	★
H2-38	Velocity-ring proportional gain of 1	1~100	30	☆
H2-39	Velocity loop integration time of 1	0.01s~10.00s	0.50s	☆
H2-40	Switch frequency 1	0.00~H2-43	5.00Hz	☆
H2-41	Velocity-loop proportional gain of 2	1~100	20	☆
H2-42	Velocity loop integration time 2	0.01s~10.00s	1.00s	☆
H2-43	Switch frequency 2	H2-40 to the maximum frequency	10.00Hz	☆
H2-44	Vector-controlled turn-difference gain	50%~200%	100%	☆
H2-45	Velocity loop filtering time constant	0.000s~0.100s	0.050s	☆
H2-46	Vector-controlled overexcitation gain	0~200	64	☆
H2-47	Torque upper limit source under speed control mode	0: H2-48 setting 1: AI1 2: AI2 3: AI3 4: The PULSE pulse 5: Communication given 6: MIN (AI1,AI2) 7: MAX (AI1,AI2) Full range of option 1-7, corresponding to H2-48 number	0	☆
H2-48	Set the torque upper limit number in the speed control mode	0.0%~200.0%	150.0%	☆
H2-51	Excitation regulation proportional gain	0~20000	2000	☆
H2-52	Excitation regulation of integral gain	0~20000	1300	☆
H2-53	Torque regulation proportional gain	0~20000	2000	☆
H2-54	Torque adjustment	0~20000	1300	☆

H2-55	Velocity loop integral property	Individual bit: integral separation 0: invalid 1: valid	0	☆
H2-61	2nd Motor control mode	2: V / F control	2	★
H2-62	2nd motor acceleration and deceleration time selection	0: Same as the first motor 1: acceleration and deceleration time 1 2: acceleration and deceleration time 2 3: acceleration and deceleration time 3 4: acceleration and deceleration time 4	0	☆
H2-63	2nd motor torque lift	0.0%: Automatic torque lift 0.1%~30.0%	Model determination	☆
H2-65	Second motor oscillation suppression gain	0~100	Model determination	☆
H5 group controls the optimization parameters				
H5-00	DPWM switching upper limit frequency	5.00Hz~50.00Hz	8.00Hz	☆
H5-01	PWM modulation mode	0: asynchronous modulation 1: synchronous modulation	0	☆
H5-02	Selection of dead zone compensation mode	0: No compensation 1: Compensation mode 1	1	☆
H5-03	Random PWM depth	0: Random PWM is invalid 1~10: PWM carrier frequency random depth	0	☆
H5-04	Fast flow limiting enabling	0: Not enable 1: enable	1	☆
H5-05	Current detection compensation	0~100	0	☆
H5-06	Underpressure point setting	200.0V~2000.0V	350	☆
H5-07	SVC-optimized mode selection	1: Optimization mode 1 2: Optimization mode 2	2	☆
H5-08	Time adjustment of dead zone	100%~200%	150%	☆
H5-09	Overpressure point setting	200.0V~2000.0V	Model determination	☆
H6 group analog quantity input curve setting				
H6-00	Analog quantity input curve 4 minimum input	-10.00V~H6-02	0.00V	☆
H6-01	Analog input curve 4 minimum input corresponding setting	-100.0%~+100.0%	0.0%	☆
H6-02	Simog input curve 4 inflection point 1 Input	H6-00~H6-04	3.00V	☆
H6-03	Simog input curve 4 inflection point 1 Enter the	-100.0%~+100.0%	30.0%	☆

H6-04	Simog input curve 4 inflection point 2 Input	H6-02~H6-06	6.00V	☆
H6-05	Simog input curve 4 inflection point 2 Enter the corresponding settings	-100.0%~+100.0%	60.0%	☆
H6-06	Analog quantity input curve 4 maximum input	H6-06~+10.00V	10.00V	☆
H6-07	Analog input curve 4 The maximum input corresponds to the setting	-100.0%~+100.0%	100.0%	☆
H6-08	Analog quantity input curve 5 minimum input	-10.00V~H6-10	-10.00V	☆
H6-09	Analog input curve 5 minimum input corresponds to the setting	-100.0%~+100.0%	-100.0%	☆
H6-10	Simog input curve 5 inflection point 1 Input	H6-08~H6-12	-3.00V	☆
H6-11	Simog input curve 5 inflection point 1 Enter the corresponding sett	-100.0%~+100.0%	-30.0%	☆
H6-12	Simog input curve 5 inflection point 2 Input	H6-10~H6-14	3.00V	☆
H6-13	Simog input curve 5 inflection point 2 Enter the corresponding settings	-100.0%~+100.0%	30.0%	☆
H6-14	Analog quantity input curve 5 maximum input	H6-12~+10.00V	10.00V	☆
H6-15	Analog input curve 5 maximum input corresponding setting	-100.0%~+100.0%	100.0%	☆
H6-24	A11 sets the jump point	-100.0%~100.0%	0.0%	☆
H6-25	A11 sets the jump amplitude	0.0%~100.0%	0.5%	☆
H6-26	A12 sets the jump point	-100.0%~100.0%	0.0%	☆
H6-27	A12 sets the jump amplitude	0.0%~100.0%	0.5%	☆
H6-28	A13 sets the jump point	-100.0%~100.0%	0.0%	☆
H6-29	A13 sets the jump amplitude	0.0%~100.0%	0.5%	☆
H9 group The dormant awake functional parameter				
H9-00	Sleep call open	0: The sleep wake-up function is invalid 1: The dormant wake function is effect	0	☆

H9-01	Dormancy frequency	0.00Hz~P0-10	20.00Hz	☆
H9-02	Sleep delay	0.0s~3600.0s	5.0s	☆
H9-03	Wake up the value	0.0%~100.0%	60.0%	☆
H9-04	Wake up delay	0.0s~3600.0s	3.0s	☆
H9-05	Pressure setting	0.0bar~H9-06	3.0bar	☆
H9-06	Sensor range	Range: 0.0~600.0bar	10.0bar	☆
HC group for both analog input and analog output correction				
HC-00	AI1 measured voltage 1	0.500V~4.000V	Factory correction	☆
HC-01	AI1 shows the voltage of 1	0.500V~4.000V	ditto	☆
HC-02	AI1 measured voltage 2	6.000V~9.999V	ditto	☆
HC-03	AI1 shows the voltage of 2	6.000V~9.999V	ditto	☆
HC-04	AI2 measured voltage 1	0.500V~4.000V	ditto	☆
HC-05	AI2 shows the voltage of 1	0.500V~4.000V	ditto	☆
HC-06	AI2 measured voltage 2	6.000V~9.999V	ditto	☆
HC-07	AI2 shows the voltage of 2	6.000V~9.999V	ditto	☆
HC-08	AI3 measured voltage 1	-9.999V~10.000V	ditto	☆
HC-09	AI3 shows the voltage of 1	-9.999V~10.000V	ditto	☆
HC-10	AI3 measured voltage 2	-9.999V~10.000V	ditto	☆
HC-11	AI3 shows the voltage of 2	-9.999V~10.000V	ditto	☆
HC-12	AO1 target voltage of 1	0.500V~4.000V	ditto	☆
HC-13	AO1 measured voltage 1	0.500V~4.000V	ditto	☆
HC-14	AO1 target voltage of 2	6.000V~9.999V	ditto	☆
HC-15	AO1 measured voltage 2	6.000V~9.999V	ditto	☆
HC-16	AO2 target voltage of 1	0.500V~4.000V	ditto	☆
HC-17	AO2 measured voltage 1	0.500V~4.000V	ditto	☆
HC-18	AO2 target voltage of 2	6.000V~9.999V	ditto	☆
HC-19	AO2 measured voltage 2	6.000V~9.999V	ditto	☆

7.2 Monitor parameter brief

FC	Designation	Minimum unit
U0 group basic monitoring parameters		
U0-00	Running frequency (Hz)	0.01Hz
U0-01	Set Frequency (Hz)	0.01Hz
U0-02	Busbar voltage (V)	0.1V
U0-03	Output voltage (V)	1V
U0-04	Output (A)	0.01A
U0-05	Output power (kW)	0.1kW
U0-06	Output torque (%)	0.1%
U0-07	DI digital input terminal input status	1
U0-08	DO output state	1
U0-09	AI1 Voltage (V)	0.01V
U0-10	AI2 Voltage (V)	0.01V
U0-11	AI3 Voltage (V)	0.01V
U0-12	Count value	1
U0-13	Length value	1
U0-14	Load speed is shown	1
U0-15	PID setting	1
U0-16	PID feedback	1
U0-17	PLC stage	1
U0-18	PULSE Input pulse frequency (Hz)	0.01kHz
U0-19	Feedback speed (in 0.1Hz)	0.1Hz
U0-20	The remaining running time	0.1Min
U0-21	AI1 pre before voltage	0.001V
U0-22	AI2 pre before voltage	0.001V
U0-23	AI3 pre before voltage	0.001V
U0-24	Linear velocity	1m/Min
U0-25	Current power time	1Min
U0-26	Current power time	0.1Min
U0-27	PULSE input pulse frequency	1Hz

U0-28	Communication set value	0.01%
U0-29	Encoder feedback speed	0.01Hz
U0-30	The primary frequency X is shown	0.01Hz
U0-31	The auxiliary frequency Y is shown	0.01Hz
U0-32	View any memory address value	1
U0-33	Synchronizer rotor position	0.1°
U0-34	Motor temperature value	1°C
U0-35	Target torque, (%)	0.1%
U0-36	The rotation position	1
U0-37	Power factor Angle	0.1°
U0-38	ABZ position	1
U0-39	V / F separates the target voltage	1V
U0-40	V / F separates the output voltage	1V
U0-41	DI digital input terminal input status is visually displayed	1
U0-42	DO input status is visually displayed	1
U0-43	DI digital input terminal functional status visual display 1 (01-40)	1
U0-44	DI ID Terminal Function Status 2 (Function 41-Function 80)	1
U0-45	Fault message	1
U0-59	Set the frequency of (%)	0.01%
U0-60	Running frequency (%)	0.01%
U0-61	Drive State	1
U0-62	The current failure	1

Chapter 8 Parameter description

P0 group, the basic function group

P0-00	GP type is displayed	Initial value	Related to model
	Set the scope	1	G-type (constant torque load model)
		2	P-type (fan and water pump load type)

This parameter is only used for users to view the factory model and cannot be changed.

1: A constant torque load for specified rated parameters.

2: Suitable for variable torque load with specified rated parameters (fan, water pump load)

P0-01	First electric motor control mode	Initial value	2
	Set the scope	0	Speed sensor-less vector control (SVC)
		1	Speed sensor with vector control (FVC)
		2	V/F control

0: No speed sensor and no vector control

1: Speed sensor with vector control

Refers to the closed-loop vector control, the motor end must be equipped with an encoder, and the driver must be equipped with the same type of PG card as the encoder. Suitable for high-precision speed control or torque control occasions. One drive can drive only one motor. Such as high-speed paper machinery, lifting machinery, elevator and other loads.

2: V / F control

Suitable for the load requirements are not high, or a drive to drag multiple motors, such as fan, pump class load. It can be used when one drive drags multiple motors.

Tip: The motor parameter identification process must be conducted when selecting the vector control mode. Only the accurate motor parameters can give full play to the advantages of the vector control mode. Better performance is achieved by adjusting the speed regulator parameter P2 group function code (the second motor is group H2).

For the permanent magnet synchronous motor, the speed sensor vector control is generally selected, and the V / F control can also be selected for some small-power motor applications, which does not support the speed sensor-free vector control of the permanent magnet synchronous motor

P0-02	Command source selection		Initial value	0
	Set the scope	0	Operation panel command channel (LED extinguish)	
		1	Terminal command channel (LED bright)	
		2	Communication command channel (LED flashing)	

Drive control commands include: start, stop, turn, reverse, click, etc.

0: Operation panel command channel;

The operation command is controlled by the RUN, STOP / RESET buttons on the operation panel.

1: Terminal command channel;

The multifunctional input terminal, including FWD, REV, JO GF, JOGR, etc.

2: Communication command channel

The running command is given by the upper computer through communication, which supports Modbus host communication.

This series of drive control board comes with a non-isolated RS485 communication interface, and the communication interface built on the local control board can be used directly in the case of short communication distance or weak interference. If the communication distance is long or the interference is strong, the Modbus communication card must be selected.

Write control command through address 0x2000. Control command definition is shown in Appendix I: Address address definition.

P0-03	Command Source X selection		Initial value	4
	Set the scope	0	Number setting (preset frequency P0-08, UP / DOWN can be modified, power loss without memory)	
		1	Number setting (preset frequency P0-08, UP / DOWN modified, power memory)	
		2	AI1	
		3	AI2	
		4	AI3 (Keyboard potentiometer)	

		5	Pulse setting (DI5)
		6	Multiple instructions
		7	PLC
		8	PID
		9	The communication given

Select the input channel for the given frequency of the drive master. There are 10 main given frequency channels:

0: Number setting (power loss)

Set the initial value of P0-08 "Preset frequency". The set frequency value of the drive can be changed by the ▲ key of the keyboard and the ▼ key (or the UP, DOWN of the multi-function input terminal)

When the drive fails and powers on again, the set frequency value returns to P0-08 "Digital set preset frequency" value.

Set the initial value of P0-08 "Preset frequency". Can be through the keyboard ▲, ▼ key (or multi-function input terminal UP, DOWN) to change the set frequency value of the drive.

When the drive turns off and powers on again, the set frequency is the set frequency of the last power drop moment, and the correction amount of the keyboard ▲, ▼ key or terminal UP, DOWN is remembered.

It should be reminded that P0-23 is the "digital setting frequency shutdown memory selection", and P0-23 is used to select whether the frequency correction amount is remembered or cleared when the drive is shut down. P0-23 is related to shutdown, not to power loss memory, and should be paid attention to in the application.

2: AI1

3: AI2

4: AI3 (Keyboard potentiometer)

The reference frequency is determined by the analog input terminal. The A810 control board provides 2 analog input terminals (AI1, AI2) including:

AI1 is a voltage input from 0 V to 10 V ~ 10V

AI2 can be 0V~10V voltage input, or 4 mA ~ 20 mA, current input, selected by the J8 jumper on the control board

AI3 Input for the keyboard potentiometer.

AI1、AI2、AI3 The input voltage value, and the corresponding relationship curve of the target frequency, the user can freely choose.

A810 provides 5 groups of corresponding relationship curves, in which 3 groups of

curves are straight lines (corresponding to 2 points) and 2 groups of curves are any curves of the corresponding relationship of 4 points. Users can set them through P4-13~P4-27 function code and H6 group function code.

Function codes P4-33 were used to set the three-way analog input from AI 1 to AI 3 to select which group of the 5 sets of curves, respectively.

The analog input terminal is scheduled as the frequency donor, and the voltage / current input corresponds to 100.0% set, which refers to the relative maximum frequency Percentage of the 'P0-10' values.

5. Pulse is given (DI5)

The frequency is given by the terminal DI5 high speed pulse.

Specification of signal for given pulse: voltage range 9V~30V and frequency range 0 kHz ~ 100 kHz. The pulse given can only be input from the multifunctional input terminal DI5.

The relationship between the input pulse frequency of DI5 terminal and the corresponding setting is set from P4-28~P4-31, which is the linear correspondence of 2 points. 100.0% of the corresponding pulse input refers to the percentage of the relative maximum frequency P0-10.

6. Multiple instructions

When selecting the operation mode of multiple-segment instructions, it is necessary to input different state combinations of DI terminals through numbers, corresponding to different set frequency values.

Four multiple command terminals (terminal functions 12~15) and 16 states of four terminals can be set. Any 16 "multiple instructions" can be set by PC group function code.

"Multiple instructions" is the percentage of relative maximum frequency P0-10.

When the digital quantity input S terminal is used as a multi-segment instruction terminal function, it should be set accordingly in the P4 group. Please refer to the specific content Description of the relevant functional parameters of the P4 group.

7. Simple PLC

When the frequency source is a simple PLC, the running frequency source of the drive can be switched between 1 and 16 arbitrary frequency instructions. The holding time of the 16 frequency instructions and the respective acceleration and deceleration time can also be set by the user. Please refer to the relevant instructions of the PC group for details.

8. PID

Select the output of the process PID control as the running frequency. Generally used for field process closed loop control, such as constant pressure closed loop control, constant tension closed loop control and other occasions.

When applying PID as frequency source, the PA group "PID function" parameters.

9. The communication given

The mean frequency is given by the communication mode.

When the point-to-point communication slave and data is received as frequency, the host transfer data is used as communication given value (see H8 group)

P0-04	Command source Y selection		Initial value	0
	Set the scope	0	Number setting (preset frequency P0-08, UP / DOWN can be modified, power loss without memory)	
		1	Number setting (preset frequency P0-08, UP / DOWN modified, power memory)	
		2	AI1	
		3	AI2	
		4	AI3	
		5	Pulse setting (DI5)	
		6	Multiple instructions	
		7	PLC	
		8	PID	
9	The communication given			

The auxiliary frequency source is used the same as the main frequency source X when the independent frequency given channel). Referring to the relevant instructions of P0-03.

When the auxiliary frequency source is used as a superposition given (i. e., the compound realization frequency of the main frequency source X and the auxiliary frequency source Y is given), note that:

1. When the auxiliary frequency source is set by number, and the preset frequency (P0-08) does not work, the user adjusts the frequency through the keyboard ▲, ▼ keys (or UP, DOWN of multifunctional input terminals), directly on the basis of the main given frequency.

2. When the auxiliary frequency source is given by analog input (AI1, AI2, AI3) or pulse input to timing, 100% of the input setting corresponds to the auxiliary frequency source range, which can be set through P0-05 and P0-06 .

3. the frequency source is the pulse input to the timing, similar to the analog quantity given.

Tip: auxiliary frequency source Y selection and main frequency source X selection, cannot be set to the same channel, that is, P0-03 and P0-04 do not be set to the same value, otherwise it is easy to cause confusion,

P0-05	Auxiliary frequency source Y range selection when superposition		Initial value	0
	Set the scope	0	Relative to the maximum frequency	

		1	Relative to the primary frequency source X	
P0-06	Range of the auxiliary frequency source Y upon superposition		Initial value	0
	Set the scope		0%~150%	

When the frequency source is selected as "frequency superposition", these two parameters are used to determine the regulation range of the auxiliary frequency sources.

P0-05 is used to determine the object corresponding to the range of the auxiliary frequency source, which can be selected relative to the maximum frequency or relative to the main frequency source X. relative to the main frequency source, the range of the auxiliary frequency source will change with the main frequency X.

P0-07	Frequency source superposition selection		Initial value	0
	Set the scope	The unit	Frequency source selection	
		0	Main frequency source X	
		1	Results of primary and auxiliary operations (operation relationship is determined by ten digits)	
		2	The main frequency source X switches from the auxiliary frequency source Y	
		3	The main frequency source X and the main and auxiliary operation results switch	
		4	Auxiliary frequency source Y and the main and auxiliary operation results switch	
		Decade	Main and auxiliary operation relationship of frequency source	
		0	Lord + auxiliary	
		1	Lord-auxiliary	
		2	Maximum value of the two	
		3	Minimum of the two	

Select the frequency given to the channel. The frequency is given by the combination of the main frequency source X and the auxiliary frequency source Y. When the frequency source is selected as the main and auxiliary operation, the bias frequency can be set through P0-21,

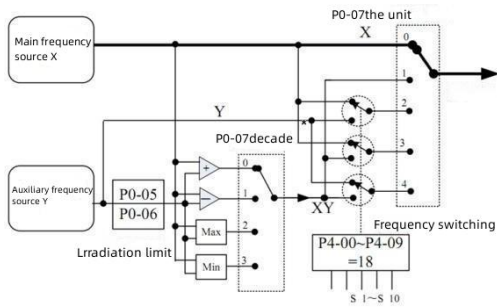

and the bias frequency can be superimposed on the main and auxiliary operation results to flexibly respond to various requirements.

P0-08	Preset frequency	Initial value	50Hz
	Set the scope	0.00 ~ Maximum frequency (valid for frequency source selection)	

When the frequency source is selected as Number setting or Terminal UP / DOWN, the function code value sets the frequency number of the drive.

P0-09	Running direction	Initial value	0
	Set the scope	0	In the same direction
		1	The opposite direction

By changing this function code, the purpose of changing the motor steering can be realized without changing the motor wiring, which is equivalent to adjusting any two lines of the motor (U, V, W) to realize the conversion of the motor rotation direction.

Tip: After the parameter initialization, the motor running direction will restore the original state. It is strictly prohibited to change the motor steering after the system debugging.

P0-10	Maximun-frequency	Initial value	50Hz
	Set the scope	50.00Hz~500.0Hz	

Pulse input (DI5), multi-segment instruction, etc., as each of the 100.0% of the frequency sources are relative to P0-10 targets. The frequency can reach 500Hz. In order to take into account the frequency command resolution and the frequency input range, the decimal number of the frequency command can be selected through P0-22

P0-11	Upper limit frequency source	Initial value	0
	Set the frequency	0	P12 setting
		1	AI1
		2	AI2
		3	AI3
		4	PULSE Setting (DI5)
		5	Communication setting

Source. The upper limit frequency can be derived from a digital setting (P0-12), or from an analog quantity input, a PULSE setting, or The communication given.

When using analog AI1, AI2, AI3 settings, PULSE setting (DI5) or communication settings, similar to the main frequency source, see P0-03.

For example, when the torque control mode is adopted in the winding control field, in order to avoid the phenomenon of "flying car", the upper limit frequency can be set with the simulated quantity. When the drive runs to the upper limit frequency value, the drive is kept at the upper limit frequency.

P0-12	Upper limiting	Initial value	50Hz
	Set the scope	Lower limit frequencies P0-14 to P 0-10	

Set the upper limit frequency, set the range P0-14~P0-10.

P0-14	Lower limit frequency	Initial value	50Hz
	Set the scope	0.00Hz ~ upper limit frequency P0-12	

When the frequency command is lower than the lower limit frequency set by P0-14, the drive can be shut down, run at the lower limit frequency or run at zero speed. The operation mode can be set by P8-14 (where the set frequency is below the lower limit frequency operation mode).

P0-15	Carrier frequency	Initial value	Related to model
	Set the scope	0.5kHz~16.0kHz	

This function adjusts the carrier frequency of the driver. By adjusting the carrier frequency, we can reduce the noise of the motor, avoid the resonance point of the mechanical system, and reduce the interference of the line to the ground drain current and the driver

When the carrier frequency is low, the high harmonic component of the output current increases, the motor loss increases, and the motor temperature rise increases.

When the carrier frequency is high, the motor loss is reduced, and the motor temperature rise decreases, but the driver loss increases, the driver temperature rise increases, and the interference increases.

Adjusting the carrier frequency affects the following performance of:

Carrier frequency	low → high
Motor dry sound	big → small
Output current waveform	bad → good
Temperature rise in electric motors	high → low
Drive temperature rise	Low → high
Leakage current	small → big
External radiation interference	small → big

Different power of the drive, the carrier frequency of the factory setting is different. Although users can modify it as needed, it should be noted that:

If the carrier frequency is set higher than the Initial value, the temperature rise of the drive radiator will increase. At this time, the user needs to use the drive drop amount, otherwise the drive is in danger of overheating alarm.

P0-16	Carrier frequency is adjusted with the temperature	Initial value	1
	Set the scope	0: No;1: Yes	

P0-17	Acceleration time 1	Initial value	Model determination
	Set the scope	0.00s~650.00s (P0-19=2) 0.0s~6500.0s (P0-19=1) 0s~65000s (P0-19=0)	
P0-18	Slow down time 1	Initial value	Model determination
	Set the scope	0.00s~650.00s (P0-19=2) 0.0s~6500.0s (P0-19=1) 0s~65000s (P0-19=0)	

Adjustment means that when the drive detects that the radiator temperature is high, it automatically reduces the carrier frequency, so as to reduce the temperature rise of the drive. When the radiator temperature is low, the carrier frequency gradually returns to the set value. This feature reduces the chance of a drive overheating alarm. The acceleration time refers to the time required for the driver to accelerate from zero frequency to the acceleration and deceleration reference frequency (P0-25 is determined), see t1 in the figure below. The deceleration time refers to the time required for the driver to decrease from the base frequency (P0-25) and from the deceleration to zero frequency, see t2 in the figure below.

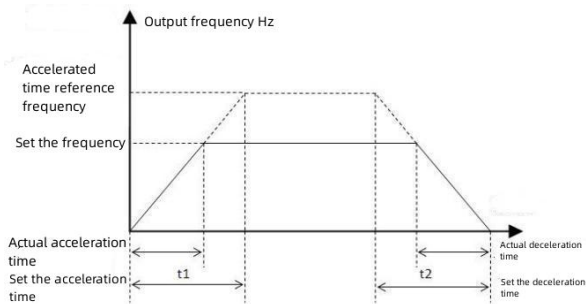

A Schematic diagram of the acceleration and deceleration time

Provide four sets of acceleration and deceleration times, and users can switch over the selection with the DI digital quantity input terminal, and the four sets of acceleration and deceleration times are set by the following function code:

Group 1: P0-17, P0-18;

Group 2: P8-03, P8-04;

Group 3: P8-05, P8-06;

Group 4: P8-07, P8-08.

P0-19	Time unit of acceleration and deceleration		Initial value	1
	0		1 s	
	1		0.1 s	
	2		0.01 s	

To meet the requirements of various fields, three time units of acceleration and deceleration time are provided, respectively, being 1 second, 0.1 second and 0.01 second.

pay attention to:

When modifying this functional parameter, the number of decimal points displayed by the 4 groups of acceleration and deceleration time will change, and the corresponding acceleration and deceleration time will also change. Special attention should be paid to the application process.

P0-21	Auxiliary frequency source offset frequency during superposition		Initial value	1
	Set the scope		0.00Hz ~ the maximum frequency P0-10	

When the frequency source is the main and auxiliary operation, P0-21 is used as the bias frequency and superimposed with the main and auxiliary operation results as the final frequency setting value, so that the frequency setting can be more flexible.

P0-22	Frequency command resolution		Initial value	2
	Set the scope	2	0.01Hz	

Parameters were used to determine the resolution of all frequency-related functional codes.

P0-23	Digital setting frequency shutdown memory selection		Initial value	0
	Set the scope	0	NO memory	
		1	Memory	

This feature is only valid when the frequency source is digital.

"No memory" refers to the number set frequency value restored to P0-08 (preset frequency) after the drive is down, the keyboard ▲, ▼ The frequency correction of the key or terminal UP or DOWN is cleared.

"Memory" means that after the digital setting frequency is stopped, the set frequency of the last shutdown time is retained, and the frequency correction of the keyboard ▲, ▼ key or terminal UP, DOWN remains valid.

P0-24	Motor parameter group selection		Initial value	0
	Set the scope	0	Motor parameter group 1	
		1	Motor parameter group 2	
P0-25	Acceleration of deceleration time reference frequency		Initial value	0
	Set the scope	0	Maximum frequency (P0-10)	
		1	Set the frequency	
		2	100Hz	

e application of the two motors, the two motors can respectively set the motor nameplate parameters, the independent parameter tuning, select different control modes, and independently set the parameters related to the operation performance, etc.

The functional parameter group corresponding to the motor parameter group 1 is groups P1 and P2, and the motor parameter group 2 corresponds to the functional parameter group group H2.

The user selects the current motor parameter group through the P0-24 function code, or they can switch the motor parameters through the digital input terminal DI. When functional code selection conflicts with terminal selection, terminal selection follows.

Acceleration and deceleration time refers to the acceleration and deceleration time from

zero frequency to the set frequency of P0-25, showing the following diagram of the acceleration and deceleration time. When P0-25 is selected as 1, the acceleration and deceleration time is related to the set frequency. If the setting frequency changes frequently, the acceleration of the motor is changed, and attention should be paid during the application.

P0-26	Runtime frequency instruction UP / DOWN baseline		Initial value	0
	Set the scope	0	Running frequency	
		1	Set the frequency	

The number is valid only if the frequency source is set as a number.

To determine the ▲, ▼ key or terminal UP / DOWN action of the keyboard, how to correct the set frequency, that is, whether the target frequency is increased or decreased from the running frequency, or from the set frequency.

The difference between the two Settings is obvious when the drive is in the acceleration and deceleration process, that is, if the running frequency of the drive is different from the set frequency, the different choices of this parameter vary greatly.

P0-27	Command source bundle frequency		Initial value	000
	Set the scope	the unit	The Action panel commands the binding frequency source selection	
		0	No bundle	
		1	The number sets the frequency source	
		2	AI1	
		3	AI2	
		4	AI3	
		5	PULSE Pulse setting (DI5)	
		6	Multiple instructions	
		7	Simple PLC	
		8	PID	
		9	The communication given	
		Decade	Terminal command binding frequency source selection (0~9, same bit)	
		Hundreds	Communication command binding frequency source selection (0~9, same bit)	

When the command source has a bundled frequency source, the frequency source set by P0-03~P0-07 no longer works during the validity period.

P0-28	Serial port communication protocol selection		Initial value	0
	Set the scope	0	MODBUS Agreement	

At present, only serial port is used to realize MODBUS communication protocol.

First motor parameters of the P1 group

P1-00	Motor type selection		Initial value	0
	Set the scope	0	Ordinary asynchronous motor	
		1	Frequency conversion asynchronous motor	
P1-01	Power rating		Initial value	Model determination
	Set the scope		0.1kW~1000.0kW	
P1-02	Rated voltage		Initial value	Model determination
	Set the scope		1V~2000V	
P1-03	Rated current		Initial value	Model determination
	Set the scope		0.01A~655.35A (Drive power <=55kW) 0.1A~6553.5A (Drive power > 55kW)	
P1-04	Rated frequency		Initial value	Model determination
	Set the scope		0.01Hz ~ the maximum frequency	
P1-05	Rated speed		Initial value	Model determination
	Set the scope		1rpm~65535rpm	

In order to obtain better V / F or vector control performance, the motor parameter tuning is required, and the accuracy of the adjustment results is closely related to the correct setting of the motor nameplate parameters.

P1-06	Asynchronous motor stator resistance	Initial value	Model determination
	Set the scope	0.001 Ω ~65.535 Ω (drive power 55kW) 0.0001 Ω ~6.5535 Ω (Drive power> 55kW)	
P1-07	Asynchronous motor rotor resistance	Initial value	Model determination
	Set the scope	0.001 Ω ~65.535 Ω (drive power 55kW) 0.0001 Ω ~6.5535 Ω (Drive power> 55kW)	
P1-08	Leakage resistance of Asynchronous motor	Initial value	Model determination
	Set the scope	0.01mH~655.35mH (Drive power: 55kW) 0.001mH~65.535mH (Drive power> 55kW)	
P1-09	Mutual inductive resistance of Asynchronous motor	Initial value	Model determination
	Set the scope	0.01mH~655.35mH (Drive power: 55kW) 0.001mH~65.535mH (Drive power> 55kW)	
P1-10	No-load current of Asynchronous motor	Initial value	Model determination
	Set the scope	0.01A~F1-03 (Drive power: 55kW) 0.1A~F1-03 (Drive power> 55kW)	

~P1-10 are the parameters of the asynchronous motors, which are generally not available on the motor nameplate, and need to be obtained through the automatic tuning of the driver. Among them, "static tuning of induction motor" can only obtain three parameters: P1-06~P1-08, while "complete tuning of induction motor" can obtain all five parameters here, but also obtain the encoder phase sequence, current ring P1 parameters, etc.

When the motor rated power (P1-01) or the motor rated voltage (P1-02) is changed, the driver will automatically modify the P1-06~ P1-10 parameter values, to restore these 5 parameters to the common standard Y series motor parameters (P1-01) .

If the asynchronous motor cannot be adjusted on site, the above corresponding function code can be entered according to the parameters provided by the motor manufacturer.

P1-27	Number of encoder lines	Initial value	1024
	Set the scope	1~65535	

Set the number of pulses per turn for the ABZ or UVW increment encoder .

In the speed sensor vector control mode, the number of encoder pulse must be set correctly, otherwise the motor will not operate properly.

P1-28	Encoder type		Initial value	0
	Set the scope	0	ABZ incremental encoder	
		1	UVW Incremental encoder	
		2	Rotary transformer	
		3	Positive cosine encoder	
		4	Provincial line mode UVW, encoder	

Support a variety of encoder types, different encoders need to choose different PG cards, please use the correct PG card purchase. Among them, synchronous motor can choose any of the five encoders, while asynchronous motor generally only choose ABZ incremental encoder and rotary transformer. After installing the PG card, P1-28 should be set correctly according to the actual situation, otherwise the drive may not run properly.

P1-30	ABZ incremental encoder AB phase sequence		Initial value	0
	Set the scope	1	Forward direction	
		2	Opposite direction	

This function code is only valid for the ABZ incremental encoder, or only for P1-28=0. Use to set the phase sequence of the ABZ incremental encoder AB signal. This function code is effective for both synchronous and asynchronous motors. As such, the AB phase sequence of the ABZ encoder can be obtained when the motor is complete or the asynchronous motor is no-load.

This parameter is only valid for synchronous motor control, and is valid for the encoder types are ABZ incremental encoder, UVW incremental encoder, rotary voltage change, and provincial line mode UVW encoder, while the cosine encoder is invalid.

P1-32	UVW, the encoder UVW phase sequence		Initial value	0
	Set the scope	0	forward direction	
		1	opposite direction	
P1-33	UVW encoder bias		Initial value	0.0°
	Set the scope		0.0°~ 359.9°	

These two parameters can be obtained in the no-load tuning and on-load tuning of the synchronous motor. These two parameters are very important for the operation of the synchronous motor, so the synchronous machine must be adjusted after the first installation.

Used to set the detection time of 0s when set to 0.0s. When the driver detects a disconnected fault and lasts beyond the P1-36 setting time, the drive alarms ERR 20.

P1-37	Tune selection		Initial value	0
	Set the scope	0	No-operation	
		1	Asynchronous static tuning	
		2	Complete tuning of the asynchronous machine	
		3	Static and complete parameter identification	

0: No operation, that is, no tuning.

1: Action description: Set the function code to 1, then press RUN, and the driver will still tune.

2: Complete tuning of asyntron

To ensure the dynamic control performance of the drive, please select the complete tuning, when the motor must be removed from the load, to keep the motor as a no-load state. During the complete tuning process, the driver first conducts static tuning, and then accelerates to 80% of the rated frequency of the motor according to the acceleration time P0-17. After a period of time, stop down according to the deceleration time P0-18 and end the tuning.

Before the complete tuning of the asynchrony, besides the motor type and motor nameplate parameters P1-00~P1-05, and the number of encoder pulse P1-27 and P1-28 shall be set correctly.

The asynchronous is fully tuned, and the driver can obtain five motor parameters from P1-06~P1-10, as well as the AB phase sequence of the encoder P1-30, Vector control current ring PI parameters P2-13~P2-16.

Action description: Set the function code to 2, then press RUN, the drive will be fully adjusted.

3: Static and complete parameter identification

It is suitable for the complete self-learning of motor parameters when the motor is still (the motor may still be slightly shaken, so pay attention to safety).

The motor type, parameters P1-00 must be correctly set before P 1-00~P1-05. The asynchronous machine is still and fully adjusted, and the driver can obtain five parameters from P1-06 to P 1-10 .

During the no-load tuning process, the driver first completes the on-load tuning, and then accelerates according to the acceleration time P0-17 to P0-08 motor rated frequency for a period of time, then stops according to the deceleration time P0-18 deceleration and ends the tuning.

Before the no-load tuning of the synchronous machine, in addition to setting the motor type and motor nameplate parameters P1-00~P1-05, the number of encoder pulse P1-27, encoder type P1-28, encoder pole logarithm P1-34.

Note: tuning can only be performed in keyboard operation mode, not motor tuning in terminal operation and communication operation mode.

P2 group of vector control parameters

P2 group functional codes are only valid for vector control and invalid for V / F control.

P2-00	The velocity-ring proportional gain of 1	Initial value	30
	Set the scope	1~100	
P2-01	The velocity loop integration time of 1	Initial value	0.50s
	Set the scope	0.01s~10.00s	
P2-02	Switch frequency 1	Initial value	5.00Hz
	Set the scope	0.00~P2-05	
P2-03	The velocity-loop proportional gain of 2	Initial value	20
	Set the scope	0~100	
P2-04	The velocity loop integration time 2	Initial value	1.00s
	Set the scope	0.01s~10.00s	
P2-05	Switch frequency 2	Initial value	10.00Hz
	Set the scope	P2-02 ~ the maximum output frequency	

The drives are run at different frequencies, and different speed loop PI parameters can be selected. When the operating frequency is less than the switching frequency 1 (P2-02), the speed ring PI operating parameters are P2-00 and P2-01. When the running frequency is greater than the switching frequency 2, the speed loop PI adjusts the parameters, such as P2-03 and P3-04. The speed ring PI parameter between the switching frequency 1 and the switching frequency 2 is the linear switching between the two groups of PI parameters, as shown in the figure below:

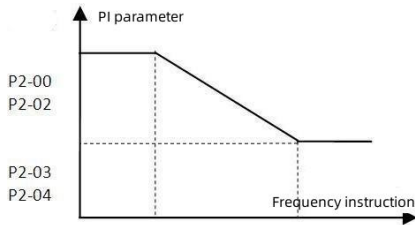

A Schematic representation of the PI parameters

The speed dynamic response characteristics of the vector control can be adjusted by setting the

proportional coefficient and integration time of the speed regulator. Increasing the proportional gain and reducing the integration time can accelerate the dynamic response of the velocity ring. But when the proportional gain is too large or the integral is used too small between them may make the system oscillate. The suggested adjustment method is as:

If the factory parameters cannot meet the requirements, first increase the Initial value parameters to ensure that the system does not oscillate, and then reduce the integration time to make the system have faster response characteristics and small overshoot.

Note: If the PI parameter is not set properly, the speed overshoot may be excessive. Even produces an overvoltage failure when the overshoot drops back.

P2-06	Vector-controlled turn-difference gain	Initial value	100%
	Set the scope	50%~200%	

For the vector control without speed sensor, this parameter is used to adjust the speed stabilization accuracy of the motor: when the motor with load speed is low, the parameter is increased, and vice versa.

With a speed sensor vector control, this parameter can adjust the output current of the driver under the same load.

P2-07	The velocity loop filtering time constant	Initial value	0.050s
	Set the scope	0.000s~0.100s	

In the vector control mode, the output of the speed loop regulator is the torque current instruction, which is used to filter the torque instruction. This parameter is generally need not be adjusted, and the filtering time can be appropriately increased when the speed fluctuation is large; if the motor has oscillation occurs, the parameter should be appropriately reduced accordingly.

The velocity ring filtering time constant is small, and the output torque of the driver may fluctuate greatly, but the velocity response is fast.

P2-20	Over-modulated voltage factor	Initial value	105%
	Set the scope	100%~110%	

used to increase the maximum output voltage capacity of the drive, the greater the increase value, the greater the maximum output voltage value, but the current ripple at the motor end will also increase accordingly, it is generally not recommended to modify.

	Moment coefficient of the	Initial value	100%
--	---------------------------	---------------	------

P2-21	constant power region		
	Set the scope	50%~200%	

The maximum torque output capacity of the drive during vector control is generally not modified

P3-00	V / F, the curve set P set		Initial value
	Set the scope		0
		1	straight line V/F
		2	multiple spot V/F
		3	square V/F
		4	1.2 times of V / F
		6	1.4 times of V / F
		8	1.6 times of V / F
		9	1.8 times of V / F
		10	hold
		11	V / F fully separated mode
		V / F semi-separated mode	

p of function code is only valid for V / F control, but not valid for vector control.

V / F control is suitable for the fan, water pumps and other general loads, or a driver with multiple motors, or the driver power and motor power difference in large applications.

0

1: Multipoint V / F. Suitable for dehydrator, centrifuge and other special loads. At this point, any V / F relationship curve can be obtained by setting the parameters P3-03~P3-08.

2: Square V / F. Suitable for the fan, water pump and other centrifugal load.

3~8: V / F relationship curve between line V / F and square V / F.

10: V / F fully separated mode. At this time, the output frequency of the driver is independent of the output voltage, and the output frequency is determined by the frequency source, and the output voltage is determined by P3-13 (V / F separation voltage source).

V / F completely separation mode, generally used in induction heating, inverter power supply, torque motor control and other occasions.

11: V / F semi-separation mode.

In this case, V and F are proportional, but the proportional relationship can be set by the voltage source P3-13, and the relationship between V and F is also related to the rated voltage and rated frequency of the motor in the P1 group.

If the voltage source input is X (X is 0~100% value), the relationship between the driver output voltage V and the frequency F is: $V / F = 2 * X * (\text{rated voltage of motor}) / (\text{rated frequency of motor})$

P3-01	Recurrent ascension	Factory value	Model determination
	Set the scope	0.0%~30%	
P3-02	Torque lift cutoff frequency	Factory value	50.00Hz
	Set the scope	0.00Hz ~ the maximum output frequency	

In order to compensate for the low frequency torque characteristics of V / F, improve the driver output voltage at low frequency. But the torque lift is set too large, the motor is easy to overheat, and the driver is easy to overflow.

When the load is heavy and the motor starting torque is insufficient, it is recommended to increase this parameter. The torque lifting can be reduced when the load is light. When the torque lift is set to 0.0, the drive is an automatic torque lift, and then the drive automatically calculates the required torque lift value according to the motor stator resistance and other parameters.

Torque lifting torque cut-off frequency: under this frequency, the torque lifting torque is valid, beyond this set frequency, the torque lifting fails, see the figure below for details.

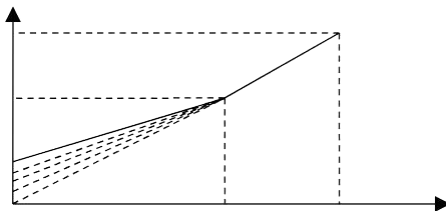

P3-03	Multipoint V / F, and frequency point F1	Initial value	0.00Hz
	Set the scope	0.00Hz~P3-05	
P3-04	Multipoint V/F ,voltage AI1	Initial value	0.0%
	Set the scope	0.0%~100.0%	
P3-05	Multipoint V / F, voltage point AI1	Initial value	0.00Hz
	Set the scope	0.0%~30%	
P3-06	Multipoint V / F voltage point AI2	Initial value	0.0%
	Set the scope	0.0%~100.0%	
P3-07	Multipoint V / F, and frequency point F3	Initial value	0.00Hz
	Set the scope	P3-05-Motor rated frequency (P1-04) Note: The second motor rated frequency is H2-04	
P3-08	Multipoint V / F, voltage point AI3	Initial value	0.0%
	Set the scope	0.0%~100.0%	

P3-03 to P 3-08 Six parameters define polysegment V / F curves.

The curve of multi-point V / F should be set according to the load characteristics of the motor. It should be noted that the relationship between the three voltage points and the frequency points must be met: $A11 < A12 < A13$, and $f1 < f2 < f3$. The following figure shows the setting diagram of the multipoint V / F curve.

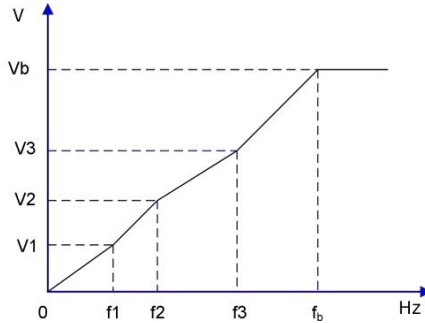

A11-A13: percent voltage of multisegment speed V / F segment 1-3 And f1-f3: percent frequency of multisegment V / F segments
1-3 Vb: rated voltage of motor fb: rated operating frequency of motor

Schematic diagram of multipoint V / F curve setting

P3-09	V / F transition compensation gain	Initial value	0.0%
	Set the scope	0% ~ 200.0%	

This parameter is only valid for the asynchronous motors.

V / F rotation compensation can compensate for the motor speed deviation generated by the asynchronous motor when the load increases, so that the speed of the motor can be basically kept stable when the load changes.

The V / F rotation compensation gain is set to 100.0%, which means that the rotation compensation of the motor with rated load is the rated slip difference of the motor, while the rated rotation difference of the motor, which is calculated by the rated frequency and rated speed of the P1 group motor.

When adjusting the V / F rotation differential compensation gain, the general principle is that the motor speed and the target speed are basically the same under the rated load. When the motor speed is different from the target value, the gain needs to be finely adjusted appropriately.

P3-10	V / F overexcitation gain	Initial value	64
	Set the scope	0~200	

During the deceleration of the drive, the overexcitation control can suppress the bus voltage rise and avoid overvoltage failure. The greater the over-excitation gain, the stronger the inhibition effect.

It is necessary to improve the overexcitation gain. However, the overexcitation gain is too large, which is easy to lead to the increase of the output current, which needs to be weighed in the application.

In cases where inertia is small, it is recommended to set the overexcitation gain to 0 and for cases with brake resistance

P3-11	V / F oscillations of the inhibitory gain	Initial value	Model determination
	Set the scope	0~100	

The selection method of this gain is to be as small as possible to avoid the adverse effects on V / F operation. Please select the gain of 0 when the motor has no oscillation phenomenon. Only when the motor is obviously oscillating, it is necessary to increase the gain appropriately, and the greater the gain is, the more obvious the inhibition of the oscillation is

P3-13	V / F separated voltage source	Initial value	0
	Set the scope	0	Number Settings (P3-14)
		1	AI1
		2	AI2
		3	AI3
		4	PULSE Pulse (DI5)
		5	Multiple instructions
		6	Simple PLC
		7	PID
		8	The communication given

		100.0% Corresponding to the motor rated voltage (P1-02、H2-02)	
P3-14	V / F separate voltage number setting	Initial value	0V
	Set the scope	0 V to motor rated voltage	

When using the suppression oscillation function, the motor rated current and no-load current parameters should be accurate, otherwise the V / F oscillation suppression effect is not good.

V / F separation is generally used in induction heating, inverter power supply and torque motor control.

When selecting the V / F separation control, the output voltage may be set by the function codes P3-14 or from the analog quantity, multiple segment command, PLC, PID, or communication given. When the non-number is set, 100% of each set corresponds to the rated motor voltage, and when the set percentage of the output such as the analog amount is negative, the set absolute value is taken as the effective set value.

0: Number setting (P3-14)

The voltage is set directly by P3-14 .

1: AI1

2: AI2

3: AI3

The voltage is determined by the analog input terminal.

4. PULSE pulse setting (DI5)

The voltage is given by the terminal pulse.

Specification of signal for given pulse: voltage range 9V~30V and frequency range 0 kHz ~ 100 kHz.

5. Multiple instructions

When the voltage source is for multiple instructions, the P4-group and PC-group parameters should be set to determine the corresponding relationship between the given signal and the given voltage. The 100.0% of the polysegment instruction given by the PC group parameters refers to the percentage of the relative rated voltage of the motor.

6. PLC

When the voltage source is a simple PLC, the PC set parameters need to be set to determine the given output voltage.

7. PID

The output voltage is generated according to the PID closed loop. For details, see the PID.

8. Communication given

The voltage is given by the upper computer through the communication mode.

V / F separation voltage source selection is similar to frequency source selection, see P0-03. Among them, 100.0% of the corresponding setting of each type of selection refers to the rated voltage of the motor (take the absolute value of the corresponding setting value).

P3-15	Voltage rise time for V / F separation	Initial value	0.0s
	Set the scope	0.0s~1000.0s	
P3-16	Voltage deceleration time for V / F separation	Initial value	0.0s
	Set the scope	0.0s~1000.0s	

The V / F separation rise time refers to the time required for the output voltage to change from 0V to the rated voltage of the motor, as shown in the figure below.

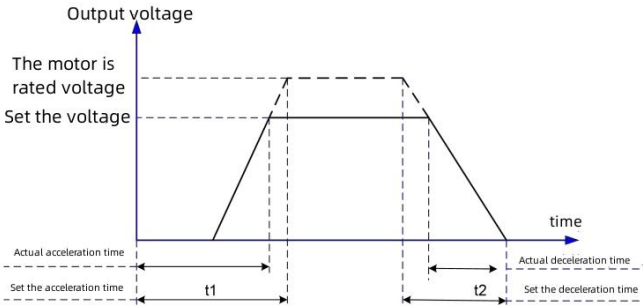

A Schematic diagram of the V / F separation

P3-17	V / F separation and shutdown mode	Initial value	0
	Set the scope	0: frequency / voltage independently reduced to 0 1: The frequency is reduced after the voltage is reduced to 0	

Depend independently to 0

The V / F separation output voltage decreases to 0V by voltage drop time (P3-15); the V / F separation output frequency decreases to 0Hz by the deceleration time (P0-18).

1: The frequency is reduced after the voltage is reduced to 0

V / F separation output voltage first decreases to 0V by voltage drop time (P3-15), and then the frequency decreases to 0Hz at deceleration time (P0-18) .

P3-18	Turn-difference compensation time constant	Initial value	0.30s
	Set the scope	0.02s~1.00s	

When the V / F rotation compensation is effective, the appropriate rotation compensation time constant can strengthen the stability of the motor speed after the rotation compensation

P3-19	Online torque compensation gain	Initial value	100%
	Set the scope	80%~150%	

The V / F control is effective with automatic torque lifting, which can strengthen the low-speed load capacity during the V / F control, generally without modification.

P4 group of input terminal

This series of drives is standard equipped with five multifunctional digital input terminals (where DI5 can be used as high-speed pulse input terminals) and two analog input terminals. If the system requires more input and output terminals, a multi-function input and output expansion card is optional. The multifunctional input and output extension card has 5 multifunctional digital input terminals (DI6~DI10) and 1 analog input terminal (AI3).

FC	Designation	Initial value	Remark
P4-00	DI1 terminal function selection	1 (forward operation)	Standard configuration
P4-01	DI2 terminal function selection	4 (positive turning point movement)	Standard configuration
P4-02	DI3 terminal function selection	9 (Fault-reset)	Standard configuration
P4-03	DI4 terminal function selection	12 (multistage speed 1)	Standard configuration
P4-04	DI5 terminal function selection	13 (multistage speed 2)	Standard configuration
P4-05	DI6 terminal function selection	0	Extend
P4-06	DI7 terminal function selection	0	Extend
P4-07	DI8 terminal function selection	0	Extend
P4-08	DI9 terminal function selection	0	Extend
P4-09	DI10 terminal function selection	0	Extend

These parameters are used to set the function of the digital multifunctional input terminals, which can be selected as shown in the table below:

Set the value	Function	Illustration
0	NF	The unused terminal can be set to "no function" to prevent misoperation.
1	Forward Turn Run	Control drive forward and reversal by external terminals.

2	Reverse Run (REV)	
3	Three-line operation control;	This terminal is used to determine how the drive operates in a three-line control mode. Refer to the work for more details Description of code P4-11 ("Terminal Command Mode").
4	Normal inching turning (FJOG)	FJOG is the point forward operation and RJOG is the point reverse operation. Point moving running frequency, point Refer to the function codes P8-00, P8-01, P8-02.
5	Reverse inching turning (RJOG)	
6	Terminal UP	An increasing, decreasing instruction to modify the frequency given by an external terminal. Set to the number at the frequency source When the word is set, the set frequency can be adjusted up and down.
7	Terminal DOWN	
8	Free parking	The driver blocks the output, and the parking process of the motor is not controlled by the driver. This way with The meaning of free parking as stated in P6-10 is the same.
9	Fault reset (RESET)	The function of fault reset using terminals. Same function as the RESET key on the keyboard. This function can achieve long-distance fault reset.
10	Run pause	The drive slows down, but all operating parameters are remembered. Such as PLC parameters, pendulum frequency parameters, PID parameters. After this terminal signal disappears, the driver returns to the operating state before shutdown.
11	External fault often open input	When the signal is sent to the driver, the driver reports the fault ERR 15, and handles the fault according to the fault protection action mode (the detailed content participates in the function code P9-47).
12	Multi-section speed terminal 1	The setting of 16 segment speeds or 16 other instructions can be achieved through the 16 states of the four terminals. Details are provided in Supplementary Table 1.
13	Multi-section speed terminal 2	
14	Multi-section speed terminal 3	
15	Multi-section speed terminal 4	
16	Select the terminal 1 during the acceleration and deceleration process	Through the four states of the two terminals, the four kinds of acceleration and deceleration time are selected, as detailed in Supplementary Table 2.
17	Increase and deceleration time selection terminal 2	
18	Frequency source switching	Used to switch to select different frequency sources. According to the setting of the frequency source selection function code (P0-07), when the switch between the two frequency sources is set as the frequency source, the terminal is used to switch between the two frequency sources.
19	UP / DOWN setting reset (terminal, keyboard)	When the frequency is given as the digital frequency and timing, this terminal can clear the frequency value changed by the terminal UP / DOWN or the keyboard UP / DOWN to restore the given frequency to that set by P0-08 price.
20	Run the command to switch over the terminals	When the command source is set to the terminal control (P0-02=1), this terminal can switch between the terminal control and the keyboard control. When the command source is set to communication control (P0-02=2), this terminal can switch between communication control

		and keyboard control.
21	Add deceleration ban	Ensure that the drive is not affected by external signals (except the shutdown command) and maintain the current output frequency.
22	PID suspend	The PID temporarily fails, and the drive maintains the current output frequency and stops performing the PID of the frequency source regulate.
23	PLC state is reset	The PLC is paused during execution, and the drive is restored through this terminal To the initial state of the simple PLC.
24	Pop-up	The drive output at a center frequency. The swing frequency function is suspended.
25	The numerator input	Count the input terminals of the pulse.
26	Counter reset	Zero up of the counter status.
27	Length count input	Input terminal for the length count.
28	Length reset	Length zero
29	The torque control is prohibited	Prohibit the drive for torque control, and the drive enters the speed control mode
30	PULSE (Pulse) frequency input (valid for DI5 only)	Function of the DI5 as a pulse-based input terminal.
31	Keep	keep
32	Instant DC brake	When the terminal is valid, the driver switches directly to the DC brake state
33	External fault is frequently closed for input	When the external fault closed signal into the drive, the driver reported the fault ERR15 and stop.
34	Frequency modification enables	If the function is set to be valid, when the frequency changes, the drive does not respond to the change in the frequency until the terminal status is invalid.
35	The direction of PID action is reversed	When this terminal is effective, the PID acts in the opposite direction as set by PA-03
36	External parking terminal 1	During keyboard control, the terminal can be used to shut down the drive, equivalent to the STOP key on the keyboard.
37	Control command to switch terminal 2	For switching between the terminal control and the communication control. If the command source is selected as terminal control, the system switches to communication control when the terminal is valid; vice versa.
38	PID points are paused	When this terminal is effective, the integral regulation function of PID is suspended, but the proportional regulation and differential regulation function of PID are still effective.
39	Frequency source X and the preset frequency changing-over	If the terminal is valid, the frequency source X is replaced with the preset frequency (P0-08)
40	Frequency source Y and the preset frequency changing-over	If the terminal is valid, the frequency source Y is replaced with the preset frequency (P0-08)
41	Motor selection terminal 1	Through the four states of the two terminals, the four sets of motor parameters can be switched. See Table 3 for details.
42	Motor selection	

	terminal 2	
43	PID parameter switching	When the PID parameter switches the condition to the DI terminal (PA-18=1), if the terminal is invalid, the PID parameter uses PA-05~PA-07; when the terminal is valid-based, it uses PA-15~PA-17;
44	User-defined fault 1	When the user custom faults 1 and 2 are valid, the driver alarms ERR 27 and ERR 28 respectively, and the driver will select the action mode selected by P9-49 according to the fault protection action texture.
45	User-defined fault 2	
46	Speed control / torque control switching	causes the drive to switch between torque control and speed control mode. When the terminal is invalid, the drive runs in a mode defined by H0-00 (speed / torque control mode), and the terminal effectively switches to another mode.
47	Emergency shutdown	When the terminal is valid, the driver stops at the fastest speed and the current is at the set current limit. This function is used to satisfy the drive when the system is in an emergency state Need to stop as soon as possible requirements.
48	External parking terminal 2	In any control mode (panel control, terminal control, communication control), the terminal can be used The drive stops down and the deceleration time is fixed to deceleration time 4.
49	Slow down DC brake	When the terminal is active, the drive slows ates to the shutdown DC brake starting frequency and then switches to The DC brake state.
50	This operation time is cleared	When the terminal is valid, the timing time of the drive is cleared, and this function should be used with the timing time operation (P8-42) and the arrival of the running time (P8-53).

Four multi-segment command terminals can be combined into 16 states, and each of these 16 states corresponds to 16 instruction sets. Details are shown in the table below:

K4	K3	K2	K1	Directive setting	Corresponding parameters
OFF	OFF	OFF	OFF	Multiparagraph Directive 0	PC-00
OFF	OFF	OFF	ON	Multiparagraph Directive 1	PC-01
OFF	OFF	ON	OFF	Multiparagraph Directive 2	PC-02
OFF	OFF	ON	ON	Multiparagraph Directive 3	PC-03
OFF	ON	OFF	OFF	Multiparagraph Directive 4	PC-04
OFF	ON	OFF	ON	Multiparagraph Directive 5	PC-05
OFF	ON	ON	OFF	Multiparagraph Directive 6	PC-06
OFF	ON	ON	ON	Multiparagraph Directive 7	PC-07
ON	OFF	OFF	OFF	Multiparagraph Directive 8	PC-08
K4	K3	K2	K1	Directive setting	Corresponding parameters
ON	OFF	OFF	ON	Multiparagraph Directive 9	PC-09

ON	OFF	ON	OFF	Multiparagraph Directive 10	PC-10
ON	OFF	ON	ON	Multiparagraph Directive 11	PC-11
ON	ON	OFF	OFF	Multiparagraph Directive 12	PC-12
ON	ON	OFF	ON	Multiparagraph Directive 13	PC-13
ON	ON	ON	OFF	Multiparagraph Directive 14	PC-14
ON	ON	ON	ON	Multiparagraph Directive 15	PC-15

When the frequency source is selected as polyspeed, 100.0% of function codes PC-00 to PC-15, corresponding to the maximum frequency P0-10. In addition to serving as a multiple segment speed function, multiple segment instructions can also serve as a given source of PID, or as a voltage source for V / F separation control, to meet the requirements of switching between different given values.

Function of acceleration and deceleration time

Terminal 2	Terminal 1	Acceleration or deceleration time selection	Corresponding parameters
OFF	OFF	Acceleration time 1	P0-17、P0-18
OFF	ON	Acceleration time 2	P8-03、P8-04
ON	OFF	Acceleration time 3	P8-05、P8-06
ON	ON	Acceleration time 4	P8-07、P8-08

Description of the motor selection terminal function

Terminal 2	Terminal 1	Motor selection	Corresponding parameter groups
OFF	OFF	Motor 1	P1 and P2 groups
OFF	ON	Motor 2	H2 group

P4-10	DI digital input terminal Filter time	Initial value	0.010s
	Set the scope	0.000s~1.000s	

Set the software filtering time for the DI digital input terminal state. If the input terminal is disturbed in the use, this parameter can be increased to enhance the anti-interference ability. However, the increased filtering time will cause the response of the DI digital input terminal to slow down.

P4-11	Terminal command mode		Initial value	0
	Set the scope	0	Two line type 1	
		1	Two line type 2	
		2	Three-line 1	
		3	Three-line 2	

This parameter defines four different ways in controlling the drive to run through an external terminal.

Note: For convenience, the three terminals of DI1, DI2 and DI3 from DI 1 to DI 10 are selected as external terminals. That is, select the functions of DI1, DI2 and DI3 three terminals by setting the values of P4-00~P4-02. See the setting range of P4-00~ P4-09.

0: Two-line Mode 1: This mode is the most commonly used two-line mode. Terminal DI1 and DI2 shall determine the forward and reverse operation of the motor. Function code is set as follows:

FC	Designation	Set point	Functional description
P4-11	Terminal command mode	0	Two line type 1
P4-00	DI1 terminal function selection	1	Forward Turn Run (FWD)
P4-01	DI2 terminal function selection	2	Reverse Run (REV)

K1	K2	Run command
1	0	corotation
0	1	reversal
1	1	stop
0	0	stop

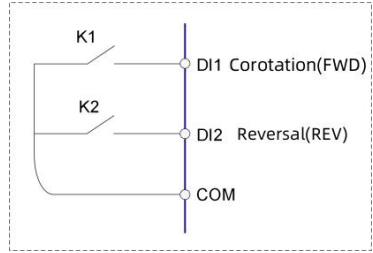

Two-line mode 1

As shown in the figure above, in this control mode, the K1 is closed and the drive is running forward. K2 closed reversal, K1, K2 closed or disconnected at the same time, the drive stopped running.

1: Two-line mode 2: In this mode, the DI1 terminal function is the running enabling terminal, while the DI2 terminal function determines the running direction. Function code is set as follows:

FC	Designation	Set point	Functional description
P4-11	Terminal command mode	1	Two line type 2
P4-00	DI1 terminal function selection	1	Run enabling
P4-01	DI2 terminal function selection	2	Positive and negative direction of operation

K1	K2	Run command
1	0	corotation
1	1	reversa
0	0	stop
0	1	stop

Two-line mode 2

As shown in the figure above, the control mode is closed in K1, K2 disconnected drive turns and K2 closed drive reverses; K1 is disconnected and the drive stops running.

2: Three-line control mode 1: This mode DI3 is an enabling terminal, and

the direction is controlled by DI1 and DI2 respectively.

This mode DI3 is the enabling terminal, and the direction is controlled by DI1 and DI2 respectively. Function code is set as follows:

FC	Designation	Set point	Functional description
P4-11	Terminal command mode	2	Three-line 1
P4-00	DI1 terminal function selection	1	Run enabling
P4-01	DI2 terminal function selection	2	Positive and negative direction of operation
P4-02	DI3 terminal function selection	3	Three-line operation control

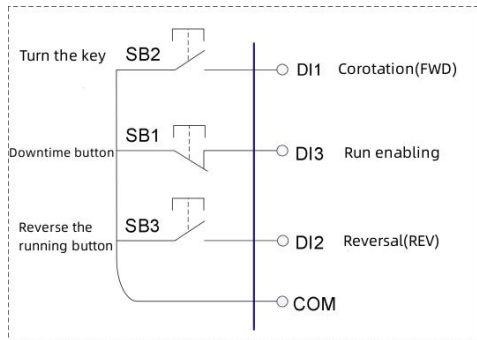

Three-line control mode 1

As shown in the figure above, the control mode is closed when the SB 1 button is closed, press the SB 2 button drive forward, press the SB 3 button drive to reverse, and the SB 1 button is disconnected. In normal start and operation, the SB 1 button must be kept closed, and the command of SB 2 and SB 3 button will take effect at the closed action edge. The running state of the drive is subject to the last button action of the 3 buttons.

3: Three-line control mode 2: The DI3 of this mode is the enabling terminal, and the operation command is given by the DI1, and the direction is determined by the state of the DI2

Function code is set as follows:

FC	Designation	Set point	Functional description
P4-11	Terminal command mode	3	Three line type 2
P4-00	DI1 terminal function selection	1	Run enabling
P4-01	DI2 terminal function selection	2	Positive and negative direction of operation
P4-02	DI3 terminal function selection	3	Three-line operation control

K	Running direction
0	corotation
1	reversal

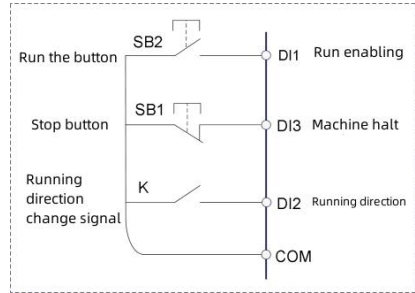

Three-line control mode 2

As shown in the figure above, the control mode is SB 1 button closed, press the SB 2 button drive operation, K disconnects the drive turn, K closes the drive reverse; the SB 1 button disconnects the drive shutdown. During normal start and operation, the command of SB 2 button must be kept closed at the closed action edge.

P4-12	Rate of change of the terminal UP / DOWN	Initial value	1.00Hz/s
	Set the scope	0.01Hz/s~65.535Hz/s	

Use to set the speed of the frequency change, when the terminal UP / DOWN adjusts the set frequency, namely, the frequency change per second.

P4-13	Analog quantity input curve 1 minimum input	Initial value	0.00V
	Set the scope	0.00V~P4-15	

P4-14	Analog quantity input curve 1 minimum input pair Should be set	Initial value	0.0%
	Set the scope	-100.00%~100.0%	
P4-15	Analog quantity input curve 1 maximum input	Initial value	10.00V
	Set the scope	P4-13~10.00V	
P4-16	Analog quantity input curve 1 maximum input Corresponding set	Initial value	100.0%
	Set the scope	-100.00%~100.0%	
P4-17	AI1 filtering time	Initial value	0.10s
	Set the scope	0.00s~10.00s	

The above function code is used to simulate the relationship between the quantity input voltage and its representative set value.

When the analog input voltage is greater than the set "maximum input" (P4-15), the analog voltage is calculated according to the "maximum input"; similarly, when the analog input voltage is less than the set "minimum input" (P4-13), the minimum input or 0.0% by the setting of "analog input below the minimum input setting selection" (P4-34).

When the analog input is a current input, the 1 mA current corresponds to a 0.5V voltage.

AI1 input filter time is used to set the software filter time of AI1. When the field simulation amount is easy to be disturbed, please increase the filter time to stabilize the simulation amount of detection, but the larger the filter time, the response speed to the simulation amount of detection is slower. How to set it up needs to be weighed according to the actual application situation.

In different applications, the corresponding nominal value meaning of the 100.0% set by the simulation is different. Please refer to the description of each application part for details.

The following legends are for two typical settings:

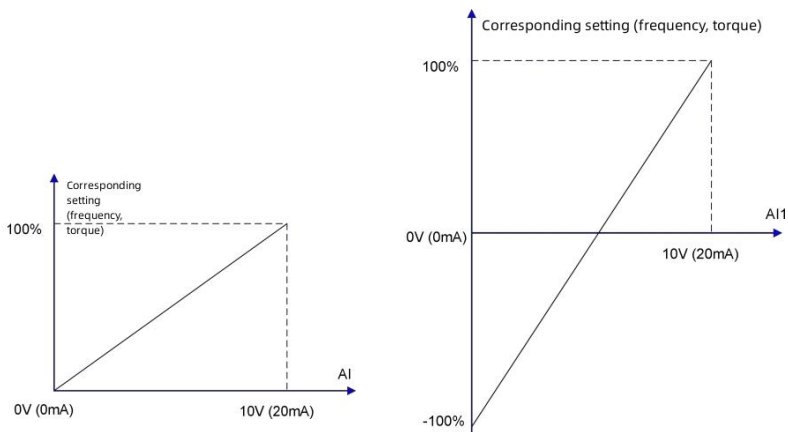

Simulation given and set the quantitative correspondence

P4-18	Analog quantity input curve 2 minimum input	Initial value	0.00V
	Set the scope	0.00V~P4-20	
P4-19	Simog input curve 2 minimum input pairs Should be set	Initial value	0.0%
	Set the scope	-100.00%~100.0%	
P4-20	Analog quantity input curve 2 maximum input	Initial value	10.00V
	Set the scope	P4-18~10.00V	
P4-21	Simog input curve 2 maximum input pairs Should be set	Initial value	100.0%
	Set the scope	-100.00%~100.0%	
P4-22	AI2 filtering time	Initial value	0.10s
	Set the scope	0.00s~10.00s	

For the function and usage method of curve 2, please refer to the description of curve 1.

P4-23	Analog quantity input curve 3 minimum input	Initial value	0.50V
	Set the scope	0.00s~P4-25	
P4-24	Analog quantity input curve 3 minimum input Corresponding set	Initial value	0.0%

	Set the scope	-100.00%~100.0%	
P4-25	Analog quantity input curve 3 maximum input	Initial value	6.6V
	Set the scope	P4-23~10.00V	
P4-26	Analog quantity input curve 3 maximum input Corresponding set	Initial value	100.0%
	Set the scope	-100.00%~100.0%	
P4-27	AI3 filtering time	Initial value	0.50s
	Set the scope	0.00s~10.00s	

For the function and usage method of curve 3, please refer to the description of curve 1.

P4-28	PULSE Minimum input	Initial value	0.00kHz
	Set the scope	00.00kHz~P4-30	
P4-29	PULSE The minimum input corresponds to the setting	Initial value	0.0%
	Set the scope	-100.00%~100.0%	
P4-30	PULSE Maximum input	Initial value	50.00kHz
	Set the scope	P4-28~50.00kHz	
P4-31	PULSE The maximum input corresponds to the setting	Initial value	100.0%
	Set the scope	-100.00%~100.0%	
P4-32	PULSE Filter time	Initial value	0.10s
	Set the scope	0.00s~10.00s	

This set of function codes is used for setting, and the relationship between the DI5 pulse frequency and the corresponding setting. The pulse frequency can only be entered into the drive through the DI5 channel.

The application of this group function is similar to curve 1, please refer to the description of curve 1.

P4-33	Analog quantity input curve selection		Initial value	321
	Set the scope	the unit	AI1 curve selection	
		1	Curve 1 (2 points, see P4-13~P4-16)	
		2	Curve 2 (2 points, see P4-18 to P 4-21)	
		3	Curve 3 (2 points, see P4-23~P4-26)	
		4	Curve 4 (4 points, see H6-00 to H 6-07)	
		5	Curve 5 (4 points, see H6-08 to H 6-15)	
		tens digit	AI2 curve selection (1 to 5, identical to above)	
hundreds	AI3 curve selection (1 to 5, identical to above)			

The individual, ten and 100 bits of the function code are used for selection, and the corresponding setting curve of the input AI1, AI2 and AI3 is simulated. The 3 simulated quantity inputs can each select any of the 5 curves.

Curves 1,2 and 3 are both 2-point curves, which are set in F4 function code, while curves 4 and 5 are both 4-point curves, which should be set in H6 function code.

The drive standard unit provides 2 analog input ports, including a multifunctional input and output expansion card using AI3.

P4-34	The analog quantity input is below the minimum input setting selection		Initial value	000
	Set the scope	the unit	AI1 is below the minimum input setting selection	
		0	Corresponding to the minimum input setting	
		1	0.0%	
		tens digit	AI2 below minimum input setting selection (0~1, same to above)	
		hundreds	AI3 below minimum input setting selection (0~1, same to above)	

The function code is used to set how the setting corresponding to the analog amount is determined when the analog amount input voltage is less than the set "minimum input".

The individual, tenth and 100 bits of the function code correspond to the analog input AI1, AI2 and AI3, respectively.

If 0 is selected, when the analog input is lower than the "minimum input", the analog corresponding is set to the curve "minimum input corresponding setting" determined by the function code (P4-14, P4-19, P4-24).

If 1 is selected, when the analog input is lower than the minimum input, the corresponding is set to 0.0%.

P4-35	DI1 delay time	Initial value	0.0s
	Set the scope	0.0s~3600.0s	
P4-36	DI2 delay time	Initial value	0.0s
	Set the scope	0.0s~3600.0s	
P4-37	DI3 delay time	Initial value	0.0s
	Set the scope	0.0s~3600.0s	

Used to set the delay time of the driver during the state change of the DI digital input terminal.

At present, only DI1, DI2, and DI3 have the function of setting the delay time

P4-38	DI digital input terminal has a valid mode selection 1		Initial value	00000
	Set the scope	the unit	DI1 terminal valid state setting	
		0	High level is effective	
		1	Low level is effective	
	myriabit	DI2 terminal valid state setting (0~1, same to above)		
		Hundred digits	DI3 terminal valid state setting (0~1, same to above)	
		kilobit	DI3 terminal valid state setting (0~1, same to above)	
		myriabit	DI5 terminal valid status setting (0~1, identical to above)	
P4-39	DI terminal valid mode selection 2		Initial value	00000
	Set the scope	the unit	DI6 terminal valid state setting	
		0	High level is effective	
		1	Low level is effective	
		myriabit	DI7 terminal valid status setting (0~1, identical to above)	
		Hundred digits	DI8 terminal valid status setting (0~1, identical to above)	
		kilobit	DI9 terminal valid status setting (0~1, identical to above)	
myriabit	DI10 terminal valid status setting (0~1, identical to above)			

e valid state mode of the DI digital input terminal.

When selected as high level is valid, the corresponding DI digital input terminal is valid when connected with the COM and is not disconnected.

When selected as low level valid, the corresponding DI digital input terminal is invalid when connected with the COM and is disconnected

P5 sets of output terminals

This series of drives is standard equipped with one multi-function analog output terminal (AO1) and one multi-function digital output terminal (DO 1), 1 multifunctional relay output terminal (TA1-TB1-TC1). The expansion card is equipped with one high-speed pulse output terminal (FM), 1 multi-function analog output terminal (AO2), 2 multi-function relay output terminals (TA2-TB2-TC2, TA3-TB3-TC3) .

P5-00	FM and AO2 terminal output mode selection	Individual bit: FM terminal function selection 0: Pulse output 1: Switch volume output (TA2-TB2-TC2) Ten- place: AO2 terminal function selection 0: Analog volume output 1: Switch volume output (TA3-TB3-TC3)	00	☆
-------	---	---	----	---

The FM terminals and TA2-TB2-TC2 are binary-multiplexed functional terminals selected by the J2 jump needle on the extension card, AO2 and TA3-TB3-TC3 it is the second choice of multiplexing function terminal, selected by the J3 jumping needle on the expansion card.

When the pulse is output as FM, the highest frequency of the output pulse is 100 kHz, see P5-06.

P5-01	Relay output function Selection (TA2-TB2-TC2)	0: No output 1: frequency converter in operation 2: fault output (it is a fault of free shutdown) 3: Frequency level detection FDT 1 Output 4: frequency reaches 5: zero speed running	0	☆
-------	---	--	---	---

P5-02	Control board relay work Opselect (TA1-TB1-TC1)	6: Motor overload forecast alarm 7: frequency converter over Forecast 8: set number number 9: designated number Value to 10: length to 11: PLC cycle completed 12: cumulative operating time reaches 13: frequency limit 14: Torque limit 15: Run readiness 16: AI1> AI2 17: Upper frequency up to 18: Lower frequency up to Up (operation related) 19: undervoltage state output 20: communication Set 21: Positioning completed (Keep) 22: positioning close (guarantee Leave) 23: zero speed operation 2 (output when shutdown) 24: Accumulated power-on time reaches 25: Frequency level detection FDT 2 output 26: frequency 1 reach output 27: frequency 2 Revival output 28: Current 1 reach output 29: current 2 Revival output 30: timing arrival output 31: AI1 input excess Limit 32: off load 33: in reverse operation 34: zero power Flow state 35: module temperature reaches 36: output current exceeds Limit 37: Lower frequency reaches (shutdown output) 38: Alarm output (all faults) 39: Motor overtemperature forecast Alarm 40: Operation time reaches 41: non-underpressure Barrier output (free shutdown)	2	☆
P5-03	Relay output function select (TA3-TB3-TC3)		0	☆
P5-04	DO 1 output function selection		1	☆
P5-05	Exhibition card DO 2 output select		4	☆

The above 5 function codes are used to select the 5 digital output functions, where TA1-TB1-TC1 is the relay on the control board. The multifunctional output terminal functions are described below:

Set point	Function	Illustration
0	No-output	The output terminal has no function
1	Drive in operation	This means that the drive is running and has an output frequency (which can be zero) When the output ON signal.
2	Fault output (fault shutdown)	When the drive fails and the fault is stopped, output ON signal.
3	FDT 1 output was detected at the frequency level	Please refer to the description of the function codes P8-19 and P8-20.
4	Frequency to arrive	Please refer to the description of the function codes P8-21.
5	Zero speed operation (No output when shutdown)	Output the ON signal when the drive is running and the output frequency is 0. In the drive is in The signal is OFF in the shutdown state.
6	Motor overload forecast alarm	Before the overload protection action of the motor, judge according to the threshold value of the overload forecast alarm, and output the ON signal after exceeding the forecast alarm threshold. Refer to the function codes P9-00~P9-02 for setting the motor overload parameters.
7	Drive overload forecast alarm	The ON signal is output 10s before the drive overload protection occurs.
8	Set the count value arrives	When the count value reaches the value set by PB-08, output ON signal.

9	Specifies that the count value arrives	When the count value reaches the value set by PB-09, output ON signal.tally function Refer to the PB group functional description
10	Length to reach	When the actual length of the detection exceeds the length set by PB-05, the ON signal is output.
11	PLC cycle is complete	When a simple PLC runs through a cycle, a 250ms width is output pulsing signal
12	Cumulative run-time arrives	ON signal when the drive exceeds the time set by P8-17.
13	Frequency limit	When the set frequency exceeds the upper or lower frequency, and the drive output frequency The ON signal is output when the upper frequency or lower frequency is also reached.
14	In the torque limit	Drive in the speed control mode, when the output torque reaches the torque limit value, The driver is in a stall-protected state while exporting the ON signal.
15	Ready for operation	When the drive main loop and control loop power supply is stable and the drive is not detected To any fault information, output the ON signal.
16	AI1>AI2	When the analog amount inputs the value of AI1 larger than the input value of AI2, the ON signal is output.
17	The upper limit frequency arrives	Output the ON signal when the running frequency reaches the upper limit frequency.
18	Lower limit frequency arrives (No output when shutdown)	When the running frequency reaches the lower limit frequency, output the ON signal. This signal is in the shutdown state For OFF.
19	Output of underpressure state	Output the ON signal when the drive is in the under-voltage state.
20	Communication setting	Please refer to the communication protocol.
21	Keep	Keep
22	Keep	Keep
23	2 at zero speed (also output during shutdown)	When the drive output frequency is 0, the ON signal is output. The signal is also used in the shutdown state For ON.
24	The cumulative power-on time arrives	When the cumulative power on time (P7-13) exceeds the set time of P8-16 ON signal.
25	FDT 2 output	Please refer to the description of the function codes P8-28 and P8-29.
26	Frequency 1 reaches the output	Please refer to the description of the function codes P8-30 and P8-31.
27	Frequency 2 reaches the output	Please refer to the description of the function codes P8-32 and P8-33.
28	Current 1 reaches the output	Please refer to the description of the function codes P8-38 and P8-39.
29	Current 2 reaches the output	Please refer to the description of the function codes P8-40 and P8-41.
30	Timed arrival output	When the timing function selection (P8-42) is valid, the running time of the drive is set After setting the timing time, output the ON signal.
31	AI1 input is overrun	When the analog value of input AI1 is greater than P8-46 (AI1 input protection upper limit) or less than At P8-45 (AI1 input protection lower limit), output the ON signal.
32	In the load	When the drive is in load state, ON output signal.

33	In reverse operation	Output the ON signal when the drive is running in reverse
34	Zero current state	Please refer to the description of the function codes P8-28 and P8-29
35	Module temperature arrives	The inverter module radiator temperature (P7-07) reaches the set module temperature The value (P8-47) shall output the ON signal
36	Software current over limit	Please refer to the description of the function codes P8-36 and P8-37.
37	Lower limit frequency reached (shutdown also output)	When the running frequency reaches the lower limit frequency, output the ON signal. The signal is also in the shutdown state For ON.
38	Alarm output	When the drive fails and the processing mode is continued Driver alarm output.
39	Motor overtemperature alarm	ON when the motor temperature reaches P9-58 (motor overheating, warning threshold) signal.(Motor temperature can be viewed through U0-34)
40	This run time arrives	Output when the drive start time exceeds the time set by P8-53 ON signal.
41	Non-undervoltage fault output	Output the ON signal when the drive has a non-undervoltage fault and stops.
42	Motor 1 variable frequency conversion contactor output	Motor 1 variable frequency conversion contactor output control
43	Motor 1 power frequency contactor output	Motor 1 power frequency contactor output control
44	Motor 2 variable frequency conversion contactor output	Motor 2 variable frequency conversion contactor output control
45	Motor 2 power frequency contactor output	Motor 2 power frequency contactor output control
46	Motor 3 variable frequency conversion contactor output	Motor 3 variable frequency conversion contactor output control
47	Motor 3 power frequency contactor output	Motor 3 power frequency contactor output control

P5-06	FMP output function selection (pulse output terminal)	Initial value	0
P5-07	AO1 output function selection	Initial value	0
P5-08	AO2 output function selection	Initial value	1

FMP terminal output pulse frequency range is 0.01 kHz to P5-09 (maximum FMP output frequency), and P 5-09 can be set between 0.01kHz~100.00kHz.

The analog output AO1 and AO2 output range from 0 V to 10 V, or 0 mA to 20 mA.

The range of pulse output or analog output and the calibration relationship of the corresponding functions are shown in the table below:

Set point	Function	Function corresponding to the pulse or analog output of 0.0%~100.0%
0	Running frequency	0~ Maximum output frequency
1	Set the frequency	0~ Maximum output frequency
2	Output(current)	0~2 x the motor rated current
3	Output torque (absolute value)	0~2 x the motor torque
4	Output power	0~2 x of the rated power
5	Output voltage	0~1.2 times the drive rated voltage
6	PULSE Pulse input	0.01kHz~100.00kHz
7	AI1	0V~10V
8	AI2	0V~10V (or 0 ~ 20 mA)
9	AI3	0V~10V
10	Length	0~ Maximum set length
11	Count value	0~ the maximum count value
12	Communication setting	0.0%~100.0%
13	Motor speed	0~ Speed corresponding to the maximum output frequency
14	Output(current)	0.0A~1000.0A
15	Output voltage	0.0V~1000.0V
16	Output torque (actual value)	-2 times motor rated torque ~2 times motor rated torque

P5-09	FMP output the maximum frequency	Initial value	50.00kHz
	Set the scope	0.01kHz~100.00kHz	

When the FM terminal is selected to be the pulse output, the function code is used to select the maximum frequency value of the output pulse.

P5-10	AO1 zero-bias coefficient	Initial value	0.0%
	Set the scope	-100.0%~+100.0%	
P5-11	AO1 gain	Initial value	1.00
	Set the scope	-10.00~+10.00	

P5-12	AO2 zero-bias coefficient	Initial value	0.00%
	Set the scope	-100.0%~+100.0%	
P5-13	AO2 gain	Initial value	1.00
	Set the scope	-10.00~+10.00	

The above functional code is generally used to correct the zero drift of the simulated output and the deviation of the output amplitude. Can also be used to customize the needed AO curve of output.

If the zero bias is represented by "b", gain by k, actual output by Y, and standard output by X, the actual output is: $Y=kX + b$.

The zero bias coefficient of AO1 and AO2 is 100% corresponds to 10V (or 20 mA), and the standard output refers to the output of 0V~10V (or 0 mA ~ 20 mA) corresponding to the analog output under no zero bias and gain correction.

For example, if the analog output is the operating frequency, hoping to output 8V when the frequency is 0, and 3V when the frequency is the maximum frequency, the gain should be set to "-0.50" and the zero bias should be set to "80%".

P5-17	FMR output delay time	Initial value	0.0s
	Set the scope	0.0s~3600.0s	
P5-18	TA1-TB1-TC1 output delay time	Initial value	0.0s
	Set the scope	0.0s~3600.0s	
P5-19	TA2-TC2 output delay time	Initial value	0.0s
	Set the scope	0.0s~3600.0s	
P5-20	DO 1 output delay time	Initial value	0.0s
	Set the scope	0.0s~3600.0s	
P5-21	DO 2 output delay time	Initial value	0.0s
	Set the scope	0.0s~3600.0s	

Set the output terminal FMR, relay 1, relay 2, DO 1 and DO 2, and set the delay time from the change of state to the actual output change.

P5-22	DO output terminal valid state selection		Initial value	00000
	Set the scope: 0- positive logic 1- antilogical	the unit	FMR valid state selection (0~1)	
		tens digit	TA1-TB1-TC1 effective status setting (0~1)	
		Hundred digits	Effective status setting of TA3-TB3-TC3 terminal (0-1)	
		kilobit	DO 1 / TA2-TB2-TC2 terminal effective status setting (0~)	
		myriabit	DO 2 / TA4-TB4-TC4 terminal active state setting (0~)	

Define the output logic of the output terminals FMR, TA1-TB1-TC1, TA2-TC2, DO 1, and DO 2 (some models extend to the relay output TA4-TB4-TC4).

0: Positive logic, the digital output terminal and the corresponding public terminal connect to the valid state and the invalid state;

1: reverse logic, the digital output terminal and the corresponding public end are connected as invalid state, disconnected as valid state.

P6 group start-stop control

P6-00	Starting mode		Initial value	0
	Set the scope	0	Direct starting	
		1	Speed tracking regain	
		2	Pre-excitation start (AC induction motor)	

0: Direct start

If the start DC braking time is set to 0, the drive starts from the start frequency. If the DC braking time is not 0, start the DC braking and then start from the start frequency. Applicable small inertial load when the motor may rotate when starting.

1: Speed tracking and restarting

The driver first judges the rotation speed and direction of the motor, and then starts with the tracked motor frequency, and implements a smooth no-shock start for the motor in the rotation. Apply the instantaneous power outage with large inertial load. In order to ensure the

performance of speed tracking and re-starting, the motor P1 set parameters should be set accurately.

2: Asynchronous machine pre-excitation start

Effective only for asynchronous motors, used to establish the magnetic field before motor operation. Refer to the function code for the preexcitation current and the preexcitation time P6-05 and P6-06 indicate.

If the preexcitation time is set to 0, the drive cancels the preexcitation process and starts from the starting frequency. Pre-excitation time is not for 0 The first pre-excitation and then start, can improve the dynamic response performance of the motor.

P6-01	Speed tracking method		Initial value	0
	Set the scope	0	Start with the shutdown frequency	
		1	Start at zero speed	
		2	Starting with the maximum frequency	
		3	Current rotation speed and direction of the motor	

To complete the speed tracking process in the shortest time, select the driver to track the motor speed:

- 0: Track down from the frequency of a power failure, usually in this way.
- 1: Track up from 0 frequency and start again in the case of long outage time.
- 2: Tracking from the maximum frequency down, general generating load use.
- 3: The current speed and direction tracking of the motor, generally used for the motor

reversal operation before starting the occasion, the tracking speed is faster, limited to V / F control mode.

P6-02	Speed tracking fast and slow	Initial value	20
	Set the scope	1~100	

When the speed tracking starts again, select the speed of the speed tracking.

The larger the parameter, the faster the tracking speed. However, an excessive setting may cause an unreliable tracking effect.

P6-03	Start frequency	Initial value	0.00Hz
	Set the scope	0.00Hz~10.00Hz	
P6-04	Start the frequency hold time	Initial value	0.0s
	Set the scope	0.0s~100.0s	

To ensure the proper motor torque, set the appropriate starting frequency. In order to

fully establish the magnetic flux when the motor starts, the starting frequency needs to be maintained for a certain time.

The starting frequency P6-03 is not limited by the lower frequency limit. However, when the target frequency is less than the start frequency, the drive does not start and is in standby state.

Start-up frequency hold time does not work during positive-reversal switching.

The startup frequency hold time is not included in the acceleration time, but is included in the run time of the simple PLC

Example 1:

P0-03 = 0 The frequency source is the number given

P0-08 = 2.00Hz Digital set frequency is

2.00Hz

P6-03 = 5.00Hz with a starting frequency of 5.00Hz

P6-04 = 2.0s starts up with a frequency hold time of 2.0s

At this point, the drive will be on standby, and the drive output frequency is 0.00Hz.

Example 2:

P0-03 = 0 The frequency source is the number given

P0-08 = 10.00Hz The number set frequency is 10.00Hz

P6-03 = 5.00Hz with a starting frequency of 5.00Hz

P6-04 = 2.0s starts up with a frequency hold time of 2.0s

At this point, the drive accelerates to 5.00Hz for 2.0s, and then it accelerates to a given frequency of 10.00Hz.

P6-05	Start the DC brake current / preexcitation current	Initial value	0%
	Set the scope	0%~100%	
P6-06	Start the DC braking time / preexcitation time	Initial value	0.0s
	Set the scope	0.0s~100.0s	

Start the DC brake, generally used to stop the running motor before starting.

Pre-excitation is used to start the induction motor and then to improve the response speed.

The starting DC brake is only valid when the start mode is a direct start. At this time, the driver first presses the set start DC braking current for the DC braking, and then starts the operation after starting the DC braking time. If the DC braking time is set to 0, it starts directly without the DC braking. The greater the DC braking current, the greater the braking force.

If the starting mode is the pre-excitation start of the asynchronous, the driver first establishes the magnetic field in advance according to the set pre-excitation current, and then starts operation after the set pre-excitation time. If the pre-excitation time is set to 0, it starts directly without the pre-excitation process.

Starting the DC brake current / preexcitation current has two situations relative to the base value.

1. When the rated current of the motor is less than or equal to 80% of the rated current of the driver, the relative rated current of the motor is the percentage base value.
2. When the rated current of the motor is greater than 80% of the rated current of the driver, the rated current of 80% of the driver is the percentage base value.

P6-07	Add deceleration mode		Initial value	0
	Set the scope	0	Straight and slow down	
		1	S-curve acceleration and deceleration of A	
		2	S-curve acceleration and deceleration of B	

Select the way the drive frequency changes during starting and stopping.

0: linear acceleration and deceleration

The output frequency increases or decreases in a straight line. The A810 provides 4 acceleration and deceleration times. Through the multifunctional digital input terminal (P4-00~P4-08) Select.

1: S-curve acceleration and deceleration A

The output frequency increases or decreases according to the S-curve. The S curve is used in places requiring gentle start or shutdown, such as elevator, conveyor belt, etc. Functional codes P6-08 and P6-09 define the proportion of time between the start and the end periods of the S-curve acceleration and deceleration, respectively.

2: S-curve acceleration and deceleration of B

In this S-curve acceleration and deceleration B, the motor is rated for frequency

The f_b is always the inflection point of the S curve. As shown in the figure below. It is generally used in high speed areas above the rated frequency.

When the set frequency is above the rated frequency, the acceleration and deceleration time is:

Where f is the set frequency, f_b is the motor rated frequency, and T is the time of acceleration from the frequency 0 to the rated frequency f_b .

P6-08	S curve start period time scale	Initial value	30.0%
	Set the scope	0.0% ~ (100.0%-P6-09)	
P6-09	S curve end period time scale	Initial value	30.0%
	Set the scope	0.0% ~ (100.0%-P6-08)	

Functional codes P6-08 and P6-09 are defined respectively, and the proportion of the beginning and end period of S curve acceleration and deceleration A needs to meet the two functional codes: P6-08 + P6-09100.0%.

In the figure below, t_1 is the parameter defined by the parameter P6-08, and the slope of the output frequency change gradually increases during this period. The t_2 is the time defined by the parameter P6-09, where the slope of the output frequency changes is gradually changed to 0. During the time between t_1 and t_2 , the slope of the output frequency change is fixed, that is, this interval performs linear acceleration and deceleration.

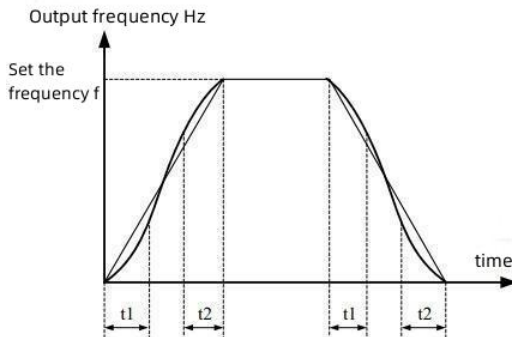

Schematic diagram of the S curve acceleration and deceleration A

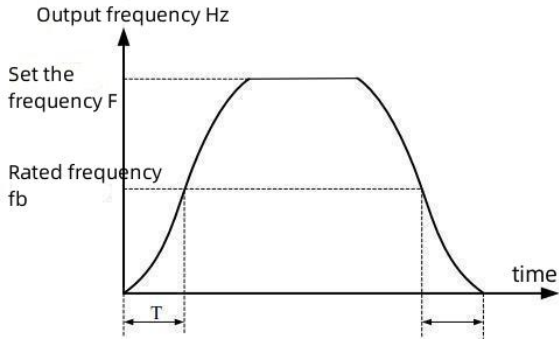

A Schematic diagram of the S curve for acceleration and deceleration B

P6-10	Downtime method		Initial value	0
	Set the scope	0	Slow down parking	
		1	Free parking	

0: Slow down and stop

After the shutdown command is valid, the driver reduces the output frequency according to the deceleration time, and the drive stops after the frequency is reduced to 0.

1: Free parking

After the shutdown command is valid, the driver immediately stops the output, and then the motor stops freely according to the mechanical inertia.

P6-11	Stop time DC brake starting frequency	Initial value	0.00Hz
	Set the scope	0.00Hz~ the maximum frequency	
P6-12	Shutdown for the DC brake waiting time	Initial value	0.0s
	Set the scope	0.0s~36.0s	
P6-13	Shutdown DC brake current	Initial value	0%
	Set the scope	0%~100%	
P6-14	Shutime DC brake time	Initial value	0.0s
	Set the scope	0.0s~36.0s	

Shutdown DC brake starting frequency: deceleration During the shutdown process, when the operating frequency is reduced to this frequency, start the DC braking process.

Waiting time of the stop DC brake: After the operating frequency is reduced to the starting frequency of the stop DC brake, the driver first stops the output for a period of time, and then starts the DC braking process. Used to prevent faults such as overcurrent possibly caused by starting DC braking at higher speeds. Stop DC brake current: parking DC brake current, relative base value has two situations.

1. When the rated current of the motor is less than or equal to 80% of the rated current of the driver, the relative rated current of the motor is the percentage base value.
2. When the rated current of the motor is greater than 80% of the rated current of the driver, the rated current of 80% of the driver is the percentage base value.

DC braking time: DC momentum holding time. This value is 0 and the DC braking process is cancelled.

The shutdown DC brake process is shown in the following figure.

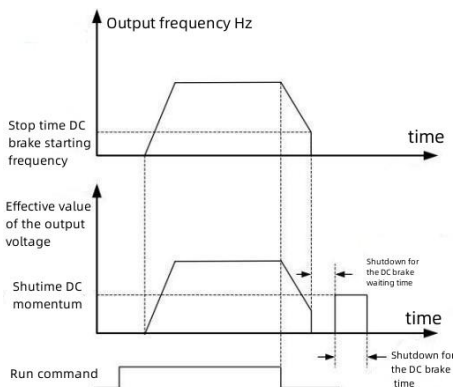

Schematic diagram of shutdown DC brake

P6-15	Brake utilization rate		Initial	100%
	Set the	0%~100%		

Only valid for drivers with a built-in brake unit.

Used to adjust the duty cycle of the braking unit, the braking utilization rate is high, the braking unit action duty cycle is high, the braking effect is strong, but the braking process drive bus voltage fluctuation is large.

P6-16	Brake unit open voltage value		Initial value	Model determination
	Set the scope	200.0V~2000.0v		

The starting voltage V_{break} of the internal brake unit action, refer to the setting of this voltage value:

$$800 \geq V_{break} \geq (1.414V_s + 30)$$

V_s -The AC supply voltage for the input drive

Note: This improper voltage setting may cause the abnormal operation of the built-in brake unit!

P6-16	Speed tracking current		Initial value	Model determination
	Set the scope	30%~200%		

The maximum current during speed tracking is limited to the speed tracking current setting. The set value is too small, and the effect of the rotation speed tracking will become worse.

P7 group keyboard and display

P7-01	JOG key function selection		Initial value	0
	Set the scope	0	Menu mode switching	
		1	The operation panel command channel switches from the remote command channel (terminal command channel or communication command channel)	
		2	Positive reversal switch	
		3	Normal inching turning	
		4	Reverse inching turning	

JOG key is a multi-function key, and the function of the JOG key can be set through this function code. This key can be switched during both shutdown and operation.

0: Menu mode switching.

1: Keyboard command and remote operation switch.

The switch of the command source, namely the current command source and the keyboard control (local operation). This key function is invalid if the current command source is keyboard controlled.

2: Forward and reverse switch

Switch the direction of the frequency instruction through the JOG key. This feature is only valid if the command source is the action panel command channel.

3: Positive point movement

Positive turn point (FJOG) by keyboard JOG key.

4: Reverse point movement

Reveractivation (RJOG) by keyboard JOG key.

P7-02	STOP / RESET key function		Initial value	1																																	
	Set the scope	0	STOP / RESET shutdown functions only in keyboard mode																																		
		1	STOP / RESET key shutdown function is valid in any operation mode																																		
P7-03	LED Run the display parameter of 1		Initial value	1F																																	
	Set the scope	0000 ~ FFFF	<table border="1"> <tr> <td>0</td> <td>Operating Frequency of 1 (Hz)</td> <td>8</td> <td>DO output state</td> </tr> <tr> <td>1</td> <td>Set Frequency (Hz)</td> <td>9</td> <td>AI1 Voltage (V)</td> </tr> <tr> <td>2</td> <td>Busbar voltage (V)</td> <td>10</td> <td>AI1 Voltage (V)</td> </tr> <tr> <td>3</td> <td>output voltage (V)</td> <td>11</td> <td>AI3 Voltage (V)</td> </tr> <tr> <td>4</td> <td>Output (A)</td> <td>12</td> <td>Count value</td> </tr> <tr> <td>5</td> <td>output power (kW)</td> <td>13</td> <td>Length value</td> </tr> <tr> <td>6</td> <td>output torque (%)</td> <td>14</td> <td>Load speed is shown</td> </tr> <tr> <td>7</td> <td>DI Input Status (V)</td> <td>15</td> <td>PID setting</td> </tr> </table>			0	Operating Frequency of 1 (Hz)	8	DO output state	1	Set Frequency (Hz)	9	AI1 Voltage (V)	2	Busbar voltage (V)	10	AI1 Voltage (V)	3	output voltage (V)	11	AI3 Voltage (V)	4	Output (A)	12	Count value	5	output power (kW)	13	Length value	6	output torque (%)	14	Load speed is shown	7	DI Input Status (V)	15	PID setting
			0	Operating Frequency of 1 (Hz)	8	DO output state																															
1	Set Frequency (Hz)	9	AI1 Voltage (V)																																		
2	Busbar voltage (V)	10	AI1 Voltage (V)																																		
3	output voltage (V)	11	AI3 Voltage (V)																																		
4	Output (A)	12	Count value																																		
5	output power (kW)	13	Length value																																		
6	output torque (%)	14	Load speed is shown																																		
7	DI Input Status (V)	15	PID setting																																		
P7-04	LED Run the display parameter 2		Initial value	0																																	
	Set the scope	0000 ~ FFFF	<table border="1"> <tr> <td>0</td> <td>PID feedback</td> <td>8</td> <td>Linear velocity</td> </tr> <tr> <td>1</td> <td>PLC stage</td> <td>9</td> <td>Current power time (Hour)</td> </tr> <tr> <td>2</td> <td>PULSE Input pulse frequency (kHz)</td> <td>10</td> <td>Current running time (Min)</td> </tr> <tr> <td>3</td> <td>Operating Frequency of 2 (Hz)</td> <td>11</td> <td>PULSE input pulse frequency (Hz)</td> </tr> <tr> <td>4</td> <td>The remaining running time</td> <td>12</td> <td>Communication set value</td> </tr> <tr> <td>5</td> <td>AI1 prefront voltage (V)</td> <td>13</td> <td>Encoder feedback speed (Hz)</td> </tr> <tr> <td>6</td> <td>AI2 prefront voltage (V)</td> <td>14</td> <td>主Frequency X display (Hz)</td> </tr> <tr> <td>7</td> <td>AI3 pre front voltage (V)</td> <td>15</td> <td>Auxiliary frequency Y display (Hz)</td> </tr> </table>			0	PID feedback	8	Linear velocity	1	PLC stage	9	Current power time (Hour)	2	PULSE Input pulse frequency (kHz)	10	Current running time (Min)	3	Operating Frequency of 2 (Hz)	11	PULSE input pulse frequency (Hz)	4	The remaining running time	12	Communication set value	5	AI1 prefront voltage (V)	13	Encoder feedback speed (Hz)	6	AI2 prefront voltage (V)	14	主Frequency X display (Hz)	7	AI3 pre front voltage (V)	15	Auxiliary frequency Y display (Hz)
			0	PID feedback	8	Linear velocity																															
1	PLC stage	9	Current power time (Hour)																																		
2	PULSE Input pulse frequency (kHz)	10	Current running time (Min)																																		
3	Operating Frequency of 2 (Hz)	11	PULSE input pulse frequency (Hz)																																		
4	The remaining running time	12	Communication set value																																		
5	AI1 prefront voltage (V)	13	Encoder feedback speed (Hz)																																		
6	AI2 prefront voltage (V)	14	主Frequency X display (Hz)																																		
7	AI3 pre front voltage (V)	15	Auxiliary frequency Y display (Hz)																																		

Run the display parameters to set the parameters that can be viewed when the drive is running.

Up to 32 state parameters are available for viewing. Select the state parameters to be displayed according to the binary values of P7-03, and the display order starts from the lowest bit of P7-03.

P7-05	LED shutdown to display the parameters		Initial value		0	
	Set the scope	0000 ~ FFFF	Set Frequency (Hz)		8	Length value
			Busbar voltage (V)		9	PLC stage
			DI input mode		10	Loading speed
			DO output state		11	PID setting
			AI1 Voltage (V)		12	PULSE input pulse frequency (kHz)
			AI2 Voltage (V)		13	Keep
			AI3 Voltage (V)		14	Keep
			Count value		15	Keep
	If the above parameters need to be displayed during shutdown, set the corresponding position to 1 and set the two The decimal number changes to hex, and then sets it to P7-05.					

P7-06	Load speed display coefficient		Initial value		1.0000	
	Set the scope	0.0001~6.5000				

When it is necessary to display the load speed, adjust the correspondence between the drive output frequency and the load speed. Refer to the description of P7-12 for the specific correspondence relationship.

P7-07	Radator temperature of		Initial value		0	
	Set the	0.0°C~100.0°C				

Show the temperature of the inverter module IGBT.

IGBT overtemperature protection value of different models.

Shpays the temperature of the rectification module.

The overtemperature protection value of the rectifier module is different for different models.

Displays the cumulative running time of the drive. When the running time reaches the set running time P8-17, the drive multi-function digital output function (12) outputs the ON signal.

P7-10	Product number		Initial value	
	Set the scope		Drive product number	
P7-11	Software version number		Initial value	
	Set the scope		Control board software version number	
P7-12	Load speed shows the decimal number		Initial value	21
	Set the scope	20	0 decimal places	
		21	One decimal place	
		22	Two decimal places	
		23	Three decimal places	

Points to set the load speed display. The following examples illustrate how the load speed is calculated:

If the load speed display coefficient P7-06 is 2.000, and the load speed decimal point P7-12 is 2 (2 decimal points), when the drive running frequency is 40.00Hz, the load speed is $40.00 * 2.000 = 80.00$ (2 decimal point). If the drive is stopped, the load speed is displayed as the speed corresponding to the set frequency, namely "set load speed". Taking the set frequency 50.00Hz as an example, the load speed of the shutdown state is: $50.00 * 2.000 = 100.00$ (2 decimal places display).

P7-13	Cumulative power time	Initial value	0h
	Set the scope	0h~65535h	

Displays the cumulative power-on time from the factory drive.

When this time reaches the set power-on time (P8-17), the driver multifunctional digital output function (24) outputs the ON signal.

P7-14	Accumulated power consumption	Initial value	-
	Set the scope	0~65535 degrees	

Shows the cumulative power consumption of the drives so far.

P7-17	Second row LED display parameters	Initial value	0
	Set the scope	0	Operating Frequency of 1 (Hz)
		1	Set Frequency (Hz)
		2	Busbar voltage (V)
		3	Output voltage (V)
		4	Output (A)
		5	Output power (kW)
6	Output torque (%)		

Auxiliary monitoring of the LED display parameters

P8 group auxiliary function

P8-00	Point movement operation frequency	Initial value	2.00Hz
	Set the scope	0.00Hz~ the maximum frequency	
P8-01	Point motion acceleration time	Initial value	20.0s
	Set the scope	0.0s~6500.0s	
P8-02	Point motion deceleration time	Initial value	20.0s
	Set the scope	0.0s~6500.0s	

Define the given frequency and the acceleration and deceleration time of the drive during the point action.

When running, the start mode is fixed as direct start mode (P6-00 =0), and the stop mode is fixed as deceleration stop (P6-10=0) .

Define the given frequency and the acceleration and deceleration time of the drive during the point action.

When running, the start mode is fixed as direct start mode (P6-00=0), and the stop mode is fixed as deceleration stop (P6-10=0).

P8-04	Slow down time 2	出	20.0s
	Set the scope	0.0s~6500.0s	
P8-05	Acceleration time 3	Initial value	20.0s
	Set the scope	0.0s~6500.0s	
P8-06	Slow down time 3	Initial value	20.0s
	Set the scope	0.0s~6500.0s	
P8-07	Acceleration time 4	Initial value	20.0s
	Set the scope	0.0s~6500.0s	
P8-08	Slow down time 4	Initial value	20.0s
	Set the scope	0.0s~6500.0s	

Provide 4 sets of acceleration and deceleration times, respectively, P0-17 / P0-18 and the above 3 sets of acceleration and deceleration times.

The definition of acceleration and deceleration time is exactly the same, please refer to P0-17 and P0-18.

Through different combinations of multi-function digital input terminal DI, four sets of acceleration and deceleration time can be selected. For the specific use method, please refer to the relevant instructions in the function codes P4-01~P4-05.

P8-09	Jump frequency 1	Initial value	0.00Hz
	Set the scope	0.00Hz~ the maximum frequency	
P8-10	Jump frequency 2	Initial value	0.00Hz
	Set the scope	0.00Hz~ the maximum frequency	
P8-11	Jump frequency amplitude	Initial value	0.00Hz
	Set the scope	0.00Hz~ the maximum frequency	

When the set frequency is within the jump frequency range, the actual running frequency will run at the jump frequency close to the set frequency. By setting the jump frequency, the driver can avoid the mechanical resonance points of the load.

Two jump frequency points can be set. If both jump frequencies are set to 0, the jump frequency function will be cancelled.

For reference to the principle of jump frequency and jump frequency amplitude, please refer to the following figure.

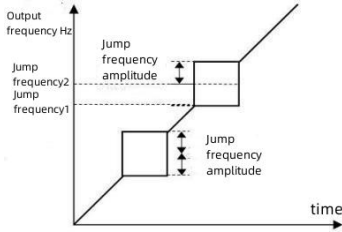

A Schematic representation of the jump frequency

P8-12		Initial value	0.0s
	Set the scope	0.00s~3000.0s	

Set the transition time at the output 0Hz during the drive positive and reverse transition, as shown in the figure below:

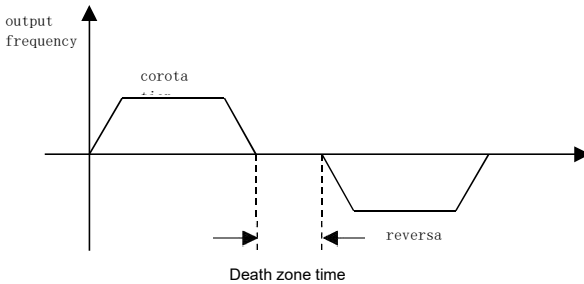

Schematic of forward and reversal dead zone time

P8-13	Reverse control enabling	Initial value	0
	Set the scope	0	permit
		1	prohibit

Number sets whether the drive is allowed to run in the reverse state, in the case that does not allow the motor reversal, to set P8-13=1.

P8-14	Set the frequency below the lower limit frequency operating mode		Initial value	0
	Set the scope	0	Run at a lower limit frequency	
		1	machine halt	
		2	Zero speed operation	

When the set frequency is below the lower limit frequency, the running state of the drive can be selected by this parameter. The A810 provides three operating modes to meet various application requirements.

P8-15	Drop control		Initial	0.00Hz
	Set the scope		0.00Hz~10.00Hz	

This function is generally used for the load distribution when multiple motors drag the same load.

Sagging control refers to the decrease of the output frequency of the driver with the increase of the load. So that when multiple motors drag the same load, the output frequency of the motor in the load decreases more, so as to reduce the load of the motor and realize the uniform load of multiple motors. This parameter refers to the output frequency decrease value of the drive at the output rated load.

P8-16	Set the cumulative power arrival time		Initial value	0h
	Set the scope		0h~65000h	

When the cumulative power time (P7-13) reaches the power time set by P8-16, the driver multifunctional digital DO outputs the ON signal. Its applications are illustrated below:

Example: Combined with the virtual DI \ DO function, the drive fault alarm output is realized after setting the power-on time for 100 hours.

Scheme:

Virtual DI1 terminal function, set to user-defined fault 1: H1-00=44;

Valid status of the terminal of virtual DI1, set to be derived from

virtual DO 1: H1-05=0000;

Virtual DO 1 function, set to reach: H1-11=24;

Set the cumulative power-on arrival time of 100 hours: P8-16=100.

When the cumulative power time reaches 100 hours, the drive fault output Err 27.

P8-17		Initial	
	Set the	0h~65000h	

For setting the run time of the drive.

When the cumulative running time (P7-09) reaches this set running time, the drive multifunctional digital DO will output the ON signal.

P8-18	Start protection options		Initial value	0
	Set the scope	0	Do not protect	
		1	Protect	

This parameter involves the security protection function of the drive.

If this parameter is set to 1, if the running command is valid at the drive (for example, before the terminal running command is closed), the drive does not respond to the running command, the running command must be removed once, and the running command is valid again before the drive responds. In addition, if this parameter is set to 1, if the running command is valid at the drive failure reset time, and the drive does not respond to the running command, and the running command must be removed first to eliminate the running protection state.

Setting this parameter to 1 can prevent the danger caused by the motor in response to the operation command when the power is on or the fault is reset.

P8-19	Frequency detection value (FDT 1)	Initial value	50.00Hz
	Set the scope	0.00Hz~ the maximum frequency	
P8-20	Frequency detection Lag value (FDT 1)	Initial value	5.0%
	Set the scope	0.0%~100.0% (FDT 1 level)	

When the running frequency is higher than the frequency detection value, the driver outputs DO output ON signal, and when the frequency is lower than the detection value, the DO output ON signal is cancelled.

The above parameters are used to set the detection value of the output frequency and the lag value of the output action. Where P8 – 20 is the percentage of the lag frequency relative to the frequency detected value, P8 – 19. Figure is a schematic representation of the FDT function.

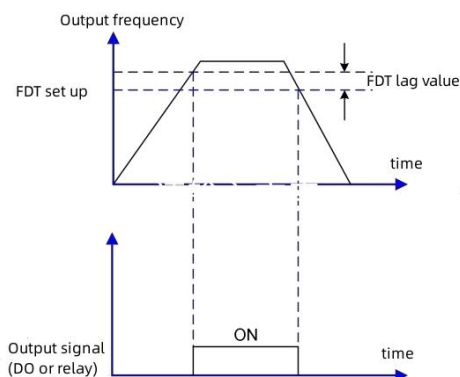

A Schematic diagram of the FDT level

P8-21	Frequency reaches the detected width	Initial value	0.0%
	Set the scope	0.00-100% (Maximum frequency)	

When the operating frequency of the drive is in a certain range of target frequency, the drive multifunctional DO outputs the ON signal.

This parameter is used to set the detection range of the frequency arrival, and this parameter is the percentage relative to the maximum frequency. The following figure shows the frequency arrival diagram.

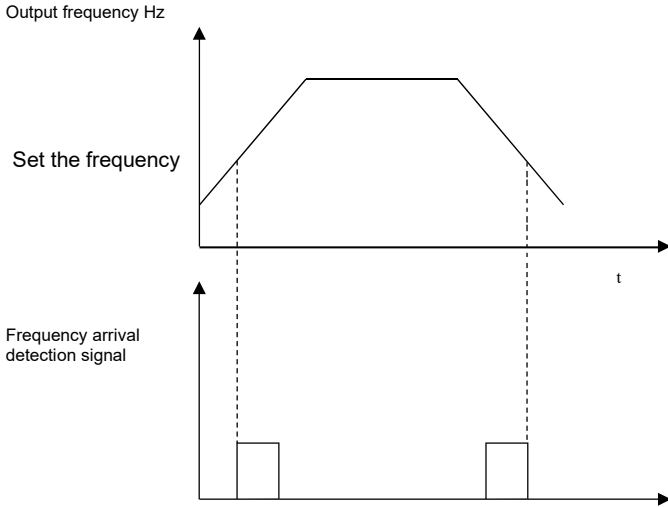

Schematic diagram of the frequency arrival detection amplitude

P8-22		Initial	0
	Set the	0: invalid	

This function code is used for setting, whether the jump frequency is valid during the acceleration and deceleration process.

When set to valid, the actual running frequency jumps the set jump frequency boundary when the running frequency is in the set jump frequency range. The following figure is a schematic diagram of the effective jump frequency during the acceleration and deceleration process.

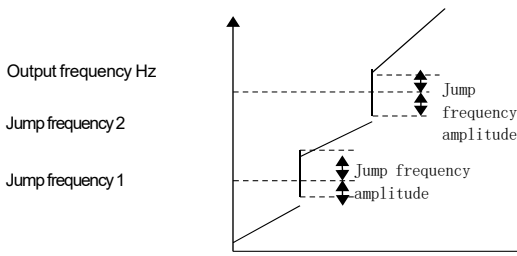

The jump frequency during the acceleration and deceleration process

P8-25	Acceleration time 1 and acceleration time 2 switch frequency points	Initial value	0.00Hz
	Set the scope	0.00Hz~ the maximum frequency	
P8-26	The ation time 1 and deceleration time 2 switch frequency points	Initial value	0.00Hz
	Set the scope	0.00Hz~ the maximum frequency	

This function is valid when the motor is selected as the motor 1 and the acceleration and deceleration time is not selected through the DI digital input terminal switch. It is used to select different acceleration and deceleration times according to the operating frequency range.

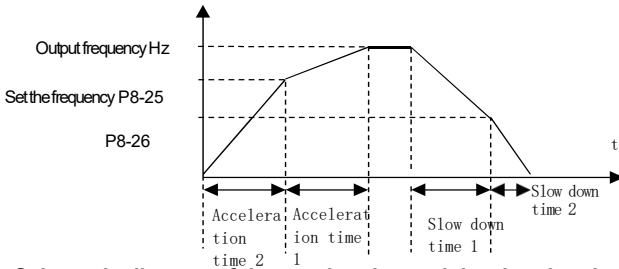

Schematic diagram of the acceleration and deceleration time switching

The above diagram is a schematic diagram of the acceleration and deceleration time switch. During the acceleration process, the acceleration time is selected if the running frequency is less than P8-25 2; Select acceleration time 1 if the run frequency is greater than P8-25.

During deceleration, deceleration time 1 is selected if the operating frequency is greater than P8-26, and deceleration time 2 if the operating frequency is less than P8-26.

P8-27	Terminal point motion is preferred	Initial value	0
	Set the scope	0: invalid 1: valid	

This parameter is used to set up whether the terminal dot movement function has the highest priority.

When the terminal point moving is active first, if the terminal point moving command appears during the operation, the drive switches to the terminal point moving running state.

P8-28	Frequency detection value (FDT 2)	Initial value	50.00Hz
	Set the scope	0.00Hz~ the maximum frequency	
P8-29	Frequency detection Lag value (FDT 2)	Initial value	5.0
	Set the scope	0.0%~100.0% (FDT 2 level)	

The frequency detection function is exactly the same as that of FDT 1. Please refer to the relevant instructions of FDT 1, which is the description of the function codes P8-19 and P8-20.

P8-30	Arbitrary arrival frequency detection value of 1		Initial value	50.00Hz
	Set the scope	0.00Hz~ the maximum frequency		
P8-31	Arbitrary arrival frequency detection amplitude of 1		Initial value	0.0%
	Set the scope	0.0%~100.0% (maximum frequency)		
P8-32	Arbitrary arrival frequency detection value of 2		Initial value	50.00Hz
	Set the scope	0.00Hz~ the maximum frequency		
P8-33	Arbitrary arrival frequency detection amplitude of 2		Initial value	0.0%
	Set the scope	0.0%~100.0% (maximum frequency)		

When the output frequency of the drive is within the positive and negative detection amplitude range of any arrival frequency detection value, the multifunctional DO outputs the ON signal. Provide two groups of arbitrary arrival frequency detection parameters, and set the frequency value and frequency detection range respectively. The figure below is a schematic diagram of the function.

P8-34	Zero-current detection level		Initial value	5.0%
	Set the scope	0.0%~300.0% (rated current of the motor)		
P8-35	Zero-current detection delay time		Initial value	0.10s
	Set the scope	0.00s~600.00s		

When the output current of the driver is less than or equal to the zero current detection level, and the duration exceeds the zero current detection delay time, the driver multifunctional DO outputs the ON signal. The following figure shows a schematic diagram of the zero-current detection.

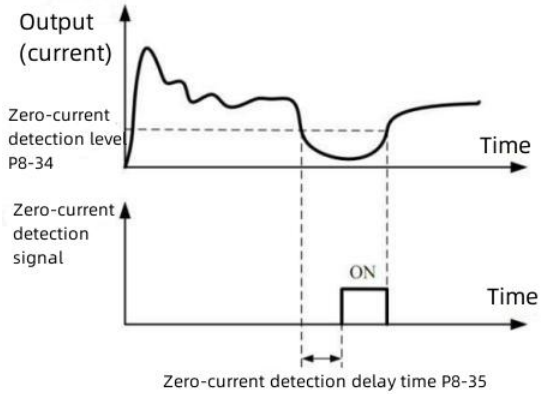

The zero-current detection process

P8-36	Output current exceeds the limit value	Initial value	200.0%
	Set the scope	0.0% (not detected) 0.1%~300.0% (rated current of the motor)	
P8-37	The output current overrun detection delay time	Initial value	0.00s
	Set the scope	0.00s~600.00s	

When the output current of the driver is greater than or over the limit detection point, and the duration exceeds the detection delay time of the software, the driver multifunctional DO output ON signal, and the following figure is the schematic diagram of the output current over the limit function.

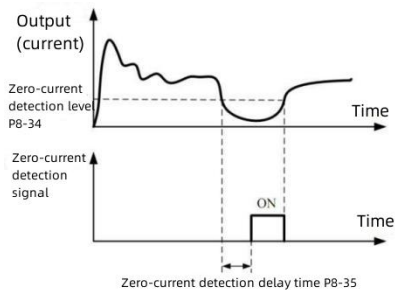

Schematic diagram of the output current over-limit detection

P8-38	Arbitrary arrival current of 1	Initial value	100.0%
	Set the scope	0.0%~300.0% (rated current of the motor)	
P8-39	Any reach current 1 width	Initial value	0.0%
	Set the scope	0.0%~300.0% (rated current of the motor)	
P8-40	Arbitrary arrival current of 2	Initial value	100.0%
	Set the scope	0.0%~300.0% (rated current of the motor)	
P8-41	Any reach current 2 width	Initial value	0.0%
	Set the scope	0.0%~300.0% (rated current of the motor)	

When the output current of the driver is set within the positive and negative detection width of any arrival current, the driver multifunctional DO output ON signal. Provide two sets of arbitrary arrival current and detected width parameters, the figure below is a functional diagram.

Time function selection	Initial value	0
Set the scope	0	invalid
	1	effective
Timed running time selection	Initial value	0
Set the scope	0	P8-44 setting
	1	AI1
	2	AI2
	3	AI3
	The og input range 100% corresponds to P8-44	
Time running time	Initial value	0.0Min
Set the scope	0.0Min~6500.0Min	

This set of parameters is used to complete the drive timing running function.

When the P8-42 timing function is selected effectively, the timing will start when the drive starts, and after reaching the set timing running time, the drive automatically stops, and the multifunctional DO outputs the ON signal.

Every time the drive starts, it starts from 0, and the remaining running time can be viewed through U0-20.

The running time is set by P8-43 and P8-44 in time of minutes.

P8-45	Lower AI1 input voltage protection value limit	Initial value	3.10V
	Set the scope	0.00V~P8-46	
P8-46	AI1 input voltage protection limit	Initial value	6.80V
	Set the scope	P8-45~10.00V	

When the value of the analog input AI1 is greater than P8-46, or the AI1 input is less than P8-45, the driver multifunctional DO outputs the "AI1 input overrun" ON signal to indicate whether the input voltage of the AI1 is within Set the scope.

P8-47	Module temperature arrives	Initial value	75℃
	Set the scope	0.00V~P8-46	

When the inverter radiator temperature reaches this temperature, the driver multifunctional DO output the "module temperature reaches" ON signal.

P8-48	Heat dissipation fan control	Initial value	0
	Set the scope	0: The fan operates during operation	

It is used to select the action mode of the cooling fan. When the driver is 0, the fan will operate in running state, if the radiator temperature is higher than 40 degrees, and the fan will not operate when the radiator is lower than 40 degrees in shutdown state.

When choosing 1, the fan operates consistently after power on.

P8-53	Arrival time of this run	Initial value	0.0Min
	Set the scope	0.0Min~6500.0Min	

When the running time of this startup reaches this time, the drive multifunctional digital DO output "this running time arrives" ON signal.

P9 group failure and protection

P9-00	Motor overload protection selection	Initial value	1
	Set the scope	0	prohibit
		1	permit
P9-01	Motor overload protection gain	Initial value	01
	Set the scope	0.20~10.00	

P9-00=0: No motor overload protection function, there may be a risk of motor overheating and damage, recommended heating relay between driver and motor;

P9-00=1: At this time, the driver determines whether the motor is overloaded according to the

reverse time limit curve of the motor overload protection.

The reverse time limit curve of motor overload protection is: 220% P9-01) motor rated current, lasting 1 minute, alarm motor overload fault; 150% (P9-01) motor rated current, lasting 60 minutes, alarm motor overload.

The user needs to set the value of P9-01 correctly according to the actual overload capacity of the motor. This parameter is set too large to cause the motor overheating and damage and the drive without alarm!

P9-02	Motor overload warning	Initial	80%
	Set the scope	50%~100%	

This function is used to give the control system a warning signal through .DO before the motor overload fault protection. This early-warning coefficient is used to determine, To much extent before motor overload protection. The larger the value, the smaller the warning amount.

When the driver output current accumulation is more than the product of the overload reverse time limit curve and P9-02, the driver multifunctional digital DO output the "motor overload forecast alarm" ON signal.

P9-03	Overpressure stall gain	Initial value	30
	Set the scope	0 (no overpressure stall) ~100	
P9-04	Over-voltage stall protection voltage	Initial value	760
	Set the scope	636~795 (3-phase)	

During the deceleration process of the driver, when the DC bus voltage exceeds the overvoltage stall protection voltage, the driver stops the deceleration and stays at the current operating frequency, and continues to slow down after the bus voltage drops.

Overvoltage stall gain to adjust the ability of the driver to suppress overvoltage during deceleration. The larger this value, the stronger the ability to suppress overpressure. In the absence of overvoltage, the smaller the gain is set, the better.

For the load of small inertia, the overvoltage stall gain should be small, otherwise the system dynamic response should be slow. For the load of large inertia, this value should be large, otherwise the suppression effect is not good, there may be overvoltage failure.

When the overvoltage stall function is cancelled
when the overvoltage stall gain .

The overvoltage stall protection voltage setting is

set as follows:

Voltage class	Over-voltage stall protection voltage value
Single phase 220V	416V
Three-phase 220V	416V
Three phase 380V	760V
Three phase 480V	889V

P9-05	Overloss speed gain	Initial value	20
	Set the scope	0~100	
P9-06	Overcurrent stall protection current	Initial value	150%
	Set the scope	100%~200%	

Over loss speed: When the output current of the driver reaches the set over current stall protection current (P9-06), the driver reduces the output frequency when accelerating; reduces the output frequency during the deceleration speed until the current is less than the over current stall protection current (P9-06). See Figure 6-24 for more details

Overcurrent stall protection current: select the current protection point of the overdrain speed function. Beyond this parameter value the drive performs the overcurrent stall protection function. The value is the percentage of the rated current of the motor.

Overloss speed gain: used to adjust the ability of the driver to suppress overflow during acceleration and deceleration. The greater this value, the stronger the ability to suppress overflow.

The less the flow, the smaller the better.

For the load of small inertia, the gain of excessive loss speed should be small, otherwise the dynamic response of the system is slow. For large inertia load, this value should be large, otherwise the suppression effect is not good, there may be overcurrent fault. In cases with very small inertia, it is recommended to set the overflow suppression gain to less than 20. When the overdrain speed function is cancelled when the overdrain speed gain set to 0.

P9-07	Power up to ground short circuit protection selection	Initial value	1
	Set the scope	0	invalid
		1	effective

The drive can be selected to check whether the motor is short circuit to the ground.

If this function is valid, the drive UVW will have a voltage output some time after power.

P9-08	Velocity limiting coefficient in V / F weak magnetic region	Initial value	200%
	Set the scope	50%~300%	

In high times weak magnetic area, the motor drive current is small, relative to the rated frequency, the same stall current, the speed of the motor drop is very big, in order to improve the running characteristics of the motor, can reduce the rated frequency above stall action current, in some centrifuge running frequency is higher, requires several times weak magnetic and large load inertia, this method has a good effect on acceleration performance.

Transition stall action current above rated frequency = $(f_s / f_n) * k * \text{LimitCur}$;

The f_s is the operating frequency, f_n is the rated frequency of the motor, k is

P9-08 "V / F weak magnetic region velocity flow limiting coefficient", and

LimitCur is P9-06 "over loss speed action current";

P9-09	Number of automatic reset	Initial value	0
	Set the scope	0~20	

Use to set the number of times that can be automatically reset when the drive can select a fault automatic reset. After this number, the drive remains in a fault state.

P9-10	Fault DO action selection during fault automatic reset	Initial value	1
	Set the scope	0: Do not move 1: Action	

If the fault automatic reset function is set on the drive, whether the fault DO is active during the fault automatic reset period can be passed P9-10 settings.

P9-11	Automatic fault reset interval time	Initial value	1.0s
	Set the scope	0.1s~100.0s	

Self-drive fault alarm, the waiting time between automatic fault reset.

P9-12	Enter the missing phase-protection selection	Initial value	1
	Set the scope	0: Prohibit 1: Allow	

Select whether to protect the input missing phase or contactor suction.

Only power models above 30KW have input phase protection, and the following power segment has no input phase protection function, whether P9-12 is set to 0 or 1.

P9-13	Output the missing phase protection selection	Initial value	1
	Set the scope	0: Prohibit 1: Allow	

Select whether to protect the output missing phase.

P9-14	First-time fault type	0~99
P9-15	The second failure type	
P9-16	Third (most recent) fault type	

Record the last three fault types of the drive, and 0 is no fault. Refer to chapter 8 for the possible causes and solutions of each fault code.

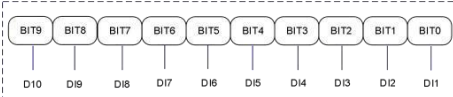
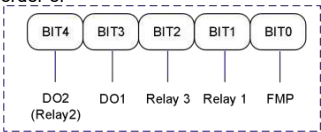
P9-17	Frequency at the third failure	Frequency of the most recent failure
P9-18	Current at the third failure	Current at the latest failure
P9-19	Bus voltage at the third failure	Bus voltage at the latest failure
P9-20	Enter the terminal status for the third failure	<p>The state of the digital input terminal at the latest fault, and the order is:</p>  <p>When the input terminal is ON and the corresponding secondary level is 1, the OFF is 0, the state of all Ds is converted to decimal numbers shown.</p>
P9-21	Output terminal at the third failure	<p>Status of all output terminals at the latest fault, in the order of</p>  <p>When the input terminal is ON and its corresponding secondary bit is 1, and OFF is 0, all The state of the DI is converted to a decimal number display.</p>
P9-22	Drive status at the third failure	Keep
P9-23	Power-on time for the third failure	Same as P9-17 to P 9-24
P9-24	Run time for the third failure	Second run time for the latest failure
P9-27	Frequency during the second failure	Same as P9-17 to P 9-24
P9-28	Current at the second fault	

P9-29	Bus voltage at the second failure	
P9-30	Enter the terminal status at the second fault	
P9-31	Output terminal at the second failure	
P9-32	Drive status at the second failure	
P9-33	Power-on time during the second failure	
P9-34	Run time for the second failure time	
P9-37	Frequency at the first failure	
P9-38	Current at the first fault	
P9-39	Bus voltage at the first failure	
P9-40	Enter the terminal status at the first failure	
P9-41	Output terminal at the first failure	
P9-42	Drive status at the first failure	
P9-43	Power time during the first failure	
P9-44	Run time during the first failure	

P9-47	Fault protection action selection 1		Initial value	00000
	Set the scope	the unit	Motor overload (Err 11)	
		0	Free shutdown	
		1	Stop by shutdown mode	
		2	Continue to run	
		tens digit	Input missing phase (Err 12) (same as the unit)	
		hundred digits	Output missing phase (Err 13) (same as the unit)	
		kilobit	External fault (Err 15) (same as the unit)	
myriabit		Communication exception (Err 16) (same as the unit)		
P9-48	Fault protection action selection 2		Initial value	00 00 0
		the unit	Encoder fault (Err 20)	
		0	Free shutdown	
		1	Switch to V / F, and stop by shutdown mode	
		2	Switch to V / F and continue running	
		tens digit	Abnormal reading and write of functional code (Err 21)	

	Set the scope	0	Free shutdown
		1	Stop by shutdown mode
		hundred digits	Keep
		kilobit	Motor overheating (Err 25) (as F9-47the unit)
		myriabit	Run arrival (Err 26) (same as F9-47the unit)
P9-49	Fault protection action selection 3	2	

	Set the scope	the unit	tens digit
		tens digit	0
		hundred digits	1
		kilobit	hundred digits
		0	Free shutdown
		1	Stop by shutdown mode
		2	Slow down to 7% of the rated frequency of the motor, and automatically return to the set frequency
myriabit	PID feedback loss (Err 31) (same as P9-47the unit)		

P9-50	Fault protection action selection 4	Initial value	00000
	Set the scope	the unit	Excessive speed deviation (Err 42) (same as P9-47the unit)
		tens digit	Motor overspeed (Err 43) (same as P9-47the unit)
		hundred digits	Initial position error (Err 51) (same as P9-47the unit)
		kilobit	Speed feedback error (Err 52) (same as P9-47the unit)
		myriabit	Keep

When selected as "Free Parking", the drive displays Err ** and stops directly.

When selecting as "Stop by shutdown mode": the drive displays A **, and stop by shutdown mode, and Err ** is displayed after the shutdown.

When selected as Continue Run: the drive keeps running and displays A **, with the running frequency set by P9-54 .

P9-54	Continue running frequency selection when failure	Initial value	0
	Set the scope	0	Run at the current operating frequency
		1	Run at a set frequency
		2	Above frequency operation
		3	Run at a lower limit frequency

		4	Run at an abnormal standby frequency	
P9-55	Abnormal backup frequency		Initial value	100.0%
	Set the scope		60.0%~100.0%	

When the fault occurs during the drive operation and the handling mode of this fault is set to continue the operation, the drive displays A * * and operates at the frequency determined by P9-54 .

When selecting the abnormal standby frequency operation, the value set by P9-55 is the percentage relative to the maximum frequency.

P9-56	Motor temperature sensor type		Initial value	0
	Set the scope	0	No temperature sensor	
		1	PT100	
		2	PT1000	
P9-57	Motor overheat protection threshold		Initial value	110℃
	Set the scope		0℃~200℃	
P9-58	Motor overheating forecast alarm threshold		Initial value	90℃
	Set the scope		0℃~200℃	

The temperature signal of the motor temperature sensor needs to be connected to the multi-function input and output expansion card, which is optional. The analog input of the expansion card is AI3, which can be used as the motor temperature sensor input, with the motor temperature sensor signal connected to AI3 and PGND terminal.

AI3 analog input, supports PT100 and PT1000 motor temperature sensors, sensor type must be set correctly. Motor temperature values are shown in U0-34.

When the motor temperature exceeds the motor overheating protection threshold P9-57, the driver fault alarm, and handle according to the selected fault protection action mode.

When the motor temperature exceeds the motor overheating forecast warning threshold P9-58, the driver multifunctional digital DO output motor overtemperature forecast alarm P ON signal.

P9-59	Instantaneous stop action choice		Initial value	0
	Set the scope	0	invalid	
		1	shift down	
		2	slow down	
P9-60	Insient stop action stops the judgment voltage		Initial value	85%
	Set the scope		0.0%~100.0%	
P9-61	Time of instantaneous power outage voltage recovery		Initial value	0.50s
	Set the scope		0.00s~100.00s	
P9-62	The instantaneous power outage action determines the voltage		Initial value	80.0%
	Set the scope		60.0%~100.0% (standard bus bar voltage)	

This function means that when an instant power failure or the voltage is suddenly reduced, the driver compensates the load to reduce the drive DC bus voltage by reducing the output speed, so as to maintain the drive to continue to operate.

If P9-59=1, when the instantaneous power is off or the voltage suddenly decreases, the driver slows down. When the bus voltage returns to normal, the driver accelerates to the set frequency operation. The basis for determining the normal and the duration exceeds the set time of P9-61.

If P9-59=2, when the instant power failure or the voltage suddenly drops, the driver slows down until shutdown.

P9-63	Loading protection options		Initial value	0
	Set the scope	0	invalid	
		1	effective	

P9-64	Desload detection level	Initial value	10.0%
	Set the scope	0.0%~100.0% (rated current of the motor)	
P9-65	Deload detection time	Initial value	1.0s
	Set the scope	0.0s~60.0s	

If the load protection function effective, the drive output frequency is automatically reduced to 7% of the rated frequency when the drive output current is less than the load detection level P9-64, and the duration is greater than the load detection time P9-65. During load drop protection, if the load is restored, the drive automatically returns to the set frequency.

P9-67	Overspeed detection value	Initial value	15.0%
	Set the scope	0.0% to 50.0% (Maximum frequency)	
P9-68	Overspeed detection time	Initial value	1.0s
	Set the scope	0.0s~60.0s	

This feature is only effective when the drive is running with a speed sensor vector control.

When the driver detects that the actual speed of the motor exceeds the maximum frequency, the excess value is greater than the overspeed detection value P9-67, and the duration is greater than the overspeed detection time P9-68, the driver fault alarms Err 43 and handles it according to the fault protection action.

When the overspeed detection time is 0.0s, cancel the overspeed fault detection.

P9-69	Excessive velocity deviation and the detection value	Initial value	20.0%
	Set the scope	0.0% to 50.0% (Maximum frequency)	
P9-70	The velocity deviation is too large for the detection time	Initial value	5.0s
	Set the scope	0.0s~60.0s	

This feature is only effective when the drive is running with a speed sensor vector control.

When the driver detects a deviation between the actual speed of the motor and the set frequency, the deviation is greater than the excessive speed deviation detection value P9-69, and the duration is greater than the excessive speed deviation detection time P9-70, the driver fault alarm Err 42, and handles it according to the fault protection action.

When the detection time of speed deviation is 0.0s, the fault detection of speed deviation is

cancelled

PA group process control PID function

PID control is a common method of process control by proportional and integrating the difference between the feedback signal and the target signal.

Differential operation, by adjusting the output frequency of the driver, forms a closed-loop system, stabilizing the controlled amount at the target value.

It is suitable for flow control, pressure control and temperature control and other process control occasions. The following figure is the control principle block diagram of the process PID.

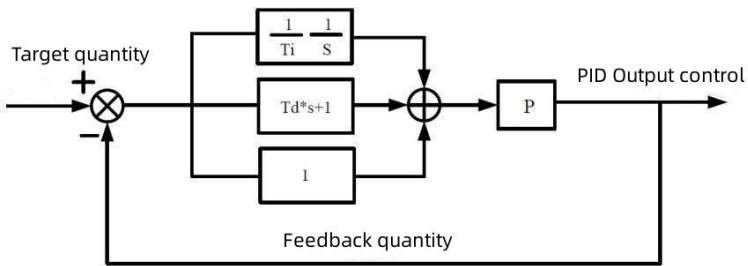

Block diagram of the process PID principle

PA-00	PID for a given source		Initial value	0
	Set the scope	0	PA-01 setting	
		1	AI1	
		2	AI2	
		3	AI3	
		4	PULSE Pulses (DI5)	
		5	communication	
6	Multiple instructions			
PA-01	PID values are given		Initial value	50.0%
	Set the scope		0.0%~100.0%	

This parameter is used to select the target amount given channel for the process PID.

The set target amount of the process PID is the relative value, and the Set the scope is from 0.0% to 100.0%. Similarly, the feedback amount of PID is also a relative amount, and the function of PID is to make these two relative amounts the same.

PA-02	PID feedback source		Initial value	0
	Set the scope	0	AI1	
		1	AI2	
		2	AI3	
		3	AI1 – AI2	
		4	PULSE Pulses (DI5)	
		5	communication	
		6	AI1+AI2	
		7	MAX (AI1 , AI2)	
8	MIN (AI1 , AI2)			

This parameter is used to select the feedback signal channel of the process PID.

The amount of feedback of the process PID was also relative value, with Set the scope ranging from 0.0% to 100.0%.

PA-03	PID application direction		Initial value	0
	Set the scope	0	Positive action	
		1	Retraction	

Positive action: When the feedback signal of PID is less than quantification, the output frequency of the driver increases. Such as receiving the volume of the tension control situation.

Retraction: When the feedback signal of PID is less than quantification, the output frequency of the driver decreases. Such as the rolling out of the tension control situation. This function is affected by the reverse direction of action of the multifunctional terminal PID (function 35), which should be noted in use.

PA-04	PID given the feedback range	Initial	1000
	Set the scope	0~65535	

The PID given feedback range is a dimensionless unit for the PID given display U0-15 with the PID feedback display U0-16.

The relative value of a given feedback for a PID is 100.0%, corresponding to a given

feedback range of PA-04. For example, if PA-04 is set to 2000, then when the PID gives 100.0%, the PID given displays U0-15 to 2000.

PA-05	Proportional gain of Kp 1	Initial value	20.0
	Set the scope	0.0~100.0	
PA-06	Integral time, Ti1	Initial value	2.00s
	Set the scope	0.01s~10.00s	
PA-07	Differential time, Td 1	Initial value	0.000s
	Set the scope	0.00~10.000	

Proportional gain of Kp 1

Determine the regulatory strength of the entire PID regulator, greater Kp 1. This parameter is the 100. 0 shows that the adjustment amplitude of the output frequency instruction when the PID feedback amount and the deviation to the quantification is 100.0% .

Integral time, Ti1:

Determine the strength of PID regulator integral regulation. The shorter the integration time, the greater the adjustment intensity. The integration time means that when the PID feedback amount and the deviation of the quantification are 100.0%, the integration regulator passes through the continuous adjustment, and the adjustment amount reaches the maximum frequency.

Differential time, Td 1:

Determines the strength of the PID regulator to the bias rate of change. The longer the differential time, the greater the adjustment intensity. Differential time means that when the feedback amount changes by 100.0% during that time, the adjustment amount of the differential regulator is the maximum frequency.

PA-08	PID reversal cutoff frequency	Initial value	0.00Hz
	Set the scope	0.00 ~maximum frequency	

In some cases, the PID is only negative when the output frequency is negative (i. e., the drive reversal), but the high reversal frequency is not allow for some cases, and PA-08 is used to determine the upper limit of the reversal frequency.

PA-09	PID deviation limit	Initial value	0.01%
	Set the scope	0. 0%~100.0%	

When the deviation between the PID-giving of the quantification and the feedback amount is less than that of PA-09, the PID stops regulating the action. In this way, the deviation between a given and the feedback is stable with a small output frequency, and is effective for some closed-loop control situations.

PA-10	PID differential limit amplitude		Initial	0.10%
	Set the scope		0.00%~100.00%	

In the PID regulator, the role of differentiation is relatively sensitive, and it is easy to cause system oscillation. Therefore, the role of PID differential is generally limited to a small range. PA-10 is used to set the range of PID differential output.

PA-11	PID given the time of change		Initial value	0.00s
	Set the scope		0.00s~650.00s	

The given time of change in PID refers to the time required for the given value of PID to change from 0.0% to 100.0% .

When a given change of PID occurs, the given value of PID changes linearly according to the given time of change, reducing the adverse effect of a given mutation on the system.

PA-12	PID feedback filtering time		Initial value	0.00s
	Set the scope	0.00s~60.00s		
PA-13	PID output filter time		Initial value	0.00s
	Set the scope	0.00s~60.00s		

PA-12 is used to filter the PID feedback, which is beneficial to reduce the influence of the feedback interference, but will reduce the response performance of the process closed-loop system.

PA-13 is used to filter the PID output frequency, which weakens the driver output frequency mutation, but also reduces the response performance of the process closed-loop system.

PA-15	Proportional gain of Kp 2		Initial value	20.0
	Set the scope		0.0~100.0	
PA-16	Integral time, Ti2		Initial value	2.00s
	Set the scope		0.01s~10.00s	
PA-17	Differential time, Td 2		Initial value	0.000s
	Set the scope		0.00~10.000	
PA-18	PID parameter switching condition		Initial value	0
	Set the scope	0	Don't switch	
		1	Switch through the DI terminal	
		2	Automatic switching according to the deviation	
PA-19	PID parameter switching deviation 1		Initial value	20.0%
	Set the scope		0.0%~PA-20	
PA-20	PID parameter switching deviation 2		Initial value	80.0%
	Set the scope		PA-19~100.0%	

In some applications, a set of PID parameters cannot meet the requirements of the whole operation process, and they need to be used in different situations PID parameter.

This set of functional codes is used to switch between the two sets of PID parameters. The regulator parameters PA-15 to PA-17 are set up, along with the parameters From PA-05 to PA-07 are similar.

The two sets of PID parameters can be switched by a multifunctional digital DI terminal or automatically according to the deviation of the PID.

When switching the multi-function DI terminal, the multi-function terminal function should be set to 43 (PID parameter switching terminal), parameter group 1 (PA-05-PA-07) at the terminal invalid, and parameter group 2 (PA-15-PA-17) at terminal effective.

When the choice is automatic switch, when the absolute value of the deviation between the given and feedback is less than the PID parameter switching deviation 1 PA-19, the PID parameter selects parameter group 1. When the absolute value of the deviation between a given and feedback is greater than the PID switching deviation 2 PA-20, the PID parameter selects the selected parameter group 2. When the deviation between given and feedback is between switching deviation 1 and 2, the PID parameter is the linear interpolation value of two groups of PID parameters, as shown in the figure below.

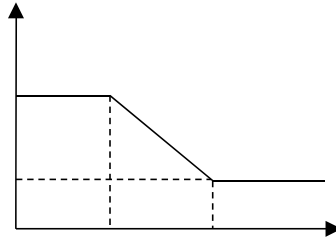

PID parameter switching

PA-21	PID initial value		Initial value	0.0%
	Set the scope	0.0%~100.0%		
PA-22	PID initial value holding time		Initial value	0.00s
	Set the scope	0.00s~650.00s		

When the drive starts, the PID output is fixed to the initial PID value PA-21, and after the initial PID value holding time PA-22, the PID starts the closed loop adjustment operation. The following figure shows a functional diagram of the initial PID value.

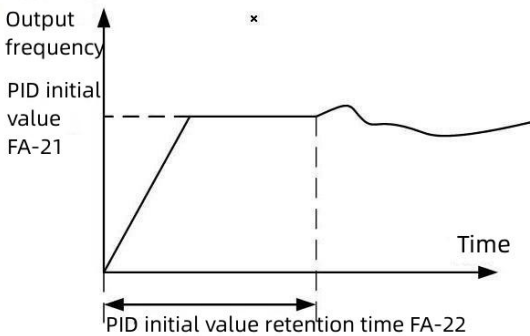

A Schematic diagram of the initial PID value function

PA-23	Two output deviation positive maximum value	Initial value	1.00%
	Set the scope	0.00%~100.00%	
PA-24	Two output deviation reverse maximum	Initial value	1.00%
	Set the scope	0.00%~100.00%	

This function is used to limit the difference between the two PID output beats (2ms / beat) to prevent the PID output from changing too fast and allow the drive to stabilize.

PA-23 and PA-24 correspond to the maximum absolute value of the output deviation at the forward and reverse directions, respectively.

PA-25	PID integration attribute		Initial value	00
	Set the scope	the unit	Integral separation	
		0	invalid	
		1	effective	
		tens digit	Whether to stop the integration after the output to the limit	
		0	Continue to integral	
1	Stop points			

Integral separation:

If the integral separation effective is set, when the multifunctional digital S integral is suspended (function 22) effective, the integral PID integration of the PID stops the operation, then the PID only proportional and differential action effective.

When the integral separation is chosen as invalid, the integral separation is invalid whether the multifunctional number S is effective or not.

Whether to stop the integration after the output to the limit:

After the PID operation output reaches the maximum or minimum value, you can choose whether to stop the integration action. If selected to stop integral, the PID integral is stopped at this time, which may help to reduce the overmodulation of PID.

PA-26	PID feedback loss detection value	Initial value	0.0%
	Set the scope	0.0%: Do not judge that the feedback is missing	

		0.1%~100.0%	
PA-27	PID feedback loss detection time	Initial value	1.0s
	Set the scope	0.0s~20.0s	

This function code is used to determine whether the PID feedback is lost.

When the PID feedback amount is less than the feedback loss detection value PA-26, and the duration exceeds the PID feedback loss detection time PA-27, the driver shall alarm the fault Err 31 and handle it according to the selected fault handling method.

PA-28	PID shutdown operation		Initial value	0
	Set the scope	0	Downtime is not operational	
		1	Downtime operation	

Used to select whether the PID will continue in the PID shutdown state. In general applications, PID should stop operation in shutdown state. However, for the dormancy and wake-up functions, the PA-28 whiskers are set to 1.

Pulum frequency, fixed length and count in Pb group

The pendulum frequency function is suitable for textile, chemical fiber and other industries, as well as the need for horizontal movement, winding function occasions.

The swing frequency function refers to the output frequency of the driver, and the set

frequency is the center. The track of the running frequency in the time axis is shown in the following figure, in which the swing amplitude is set by Pb-00 and Pb-01. When Pb-01 is set to 0, the swing frequency does not work.

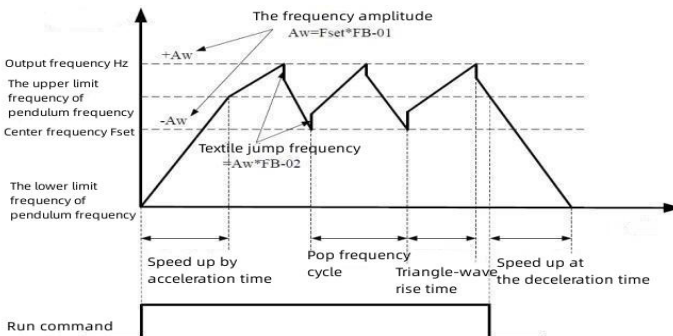

Schematic diagram of the pendulum frequency work

Pb-00	Layout setting method		Initial value	0
	Set the scope	0	Relative to the center frequency	
		1	Relative to the maximum frequency	

This parameter is used to determine the base amount of the swing amplitude.

0: Relative center frequency (P0-07 frequency source), is the variable swing system.

The swing amplitude varies with the center frequency (set frequency)。

1: relative maximum frequency (P0-10), fixed swing system with fixed swing.

Pb-01	Frequency amplitude		Initial value	0.0%
	Set the scope	0.0%~100.0%		
Pb-02	Amplitude of the jump frequency		Initial value	0.0%
	Set the scope	0.0%~50.0%		

This parameter is used to determine the swing amplitude and the sudden jump frequency value.

When the swing is set relative to the central frequency (Pb-00=0), the swing AW = frequency source P0-07 swing amplitude Pb-01. When the swing is set relative to the maximum frequency (Pb-00=1), the swing AW = the maximum frequency P0-10 Pb-01.

The burst frequency amplitude is the frequency percentage of the burst frequency relative to the swing amplitude, that is, the burst modulation frequency = swing AW jump frequency amplitude Pb-02. If the swing is selected relative to the center frequency (Pb-00=0), the spike frequency is the change value. Select the swing relative to the maximum frequency (Pb-00=1), the burst frequency is fixed.

The swing frequency is constrained by the upper and lower frequency.

Pb-03	Pop frequency cycle		Initial value	10.0s
	Set the scope	0.0s~3000.0s		
Pb-04	The coefficient of the triangular wave rise time		Initial value	50.0%
	Set the scope	0.0%~100.0%		

Tpping cycle: the time value of a complete swing period.

The delta wave rise time coefficient, Pb-04, is the percentage of time when the delta wave rise time relative to the pendulum frequency period Pb-03. Triangle wave rise time = pendulum frequency period Pb-03 Triangle wave rise time coefficient Pb-04, in seconds. Triangle wave drop time = pendulum frequency period Pb-03 (1-triangular wave rise time coefficient Pb-04) in seconds.

Pb-05	Set the length	Initial value	1000m
	Set the scope	0m~65535m	
Pb-06	physical length	Initial value	0m
	Set the scope	0m~65535m	
Pb-07	Pulse number per meter	Initial value	100.0
	Set the scope	0.1~6553.5	

The above function code is used for fixed length control.

The length information needs to be collected through the multifunctional digital input terminal, and the number of pulses sampled by the terminal is divided by the number of pulses per meter Pb-07, so the actual length Pb-06 can be calculated. When the actual length is greater than the set length Pb-05, the multifunctional digital S outputs the "length to Up to" ON signal.

During the length control process, length reset operation can be performed through the multifunctional DI digital input terminal (the DI digital input terminal is 28). please refer to P4-00~P4-09 for details.

In the application, the corresponding input terminal function should be set as "Length count input" (function 27), and the DI5 port must be used at a high pulse frequency.

Pb-08	Set the gauge value	Initial value	1000
	Set the scope	1~65535	
Pb-09	Specify the count value	Initial value	1000
	Set the scope	1~65535	

Count values need to be collected through a multifunctional digital input terminal. In the application, the corresponding input terminal function should be set as "Counter input" (function 25), and the DI5 port must be used when the pulse frequency is high.

When the count value reaches the set count value Pb-08, the multifunctional digital DO output the "set count value arrives" ON signal, and then the counter stops the count.

When the count value reaches the specified count value Pb-09, the multifunctional digital DO output the "specified count value arrives" ON signal, and the counter continues to count until the counter stops at the "Set count value".

The specified count value Pb-09 should not be greater than the set count value Pb-08. Figure 6-29 shows a schematic diagram of the set count arrival and the specified count arrival function.

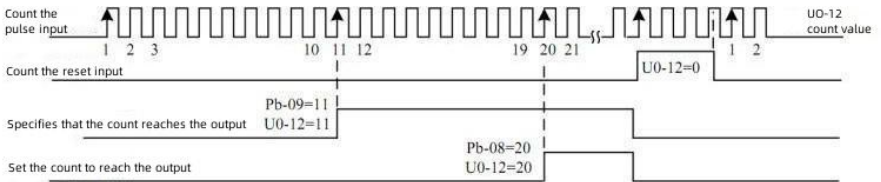

Set count value given and specified count value given schematic diagram

PC group multiparagraph instructions and simple PLC function

Multisegment command, with more abundant function than the usual multisegment speed, in addition to realizing the multisegment speed function, can also serve as a voltage source of V / F separation, as well as a given source of the process PID. For this purpose, the dimension of the multisegment instructions is the relative value.

Simple PLC can only complete the combination of multi-segment instructions.

PC-00	Multiparagraph instruction 0	Initial value	0.0%
	Set the scope	-100.0%~100.0%	
PC-01	Multiparagraph instruction 1	Initial value	0.0%
	Set the scope	-100.0%~100.0%	

PC-02	Multiparagraph instruction 2	Initial value	0.0%
	Set the scope	-100.0%~100.0%	
PC-03	Multiparagraph instruction 3	Initial value	0.0%
	Set the scope	-100.0%~100.0%	
PC-04	Multiparagraph instruction 4	Initial value	0.0%
	Set the scope	-100.0%~100.0%	
PC-05	Multiparagraph instruction 5	Initial value	0.0%
	Set the scope	-100.0%~100.0%	
PC-06	Multiparagraph instruction 6	Initial value	0.0%
	Set the scope	-100.0%~100.0%	
PC-07	Multiparagraph instruction 7	Initial value	0.0%
	Set the scope	-100.0%~100.0%	
PC-08	Multiparagraph instruction 8	Initial value	0.0%
	Set the scope	-100.0%~100.0%	
PC-09	Multiparagraph instruction 9	Initial value	0.0%
	Set the scope	-100.0%~100.0%	
PC-10	Multiparagraph instruction10	Initial value	0.0Hz
	Set the scope	-100.0%~100.0%	
PC-11	Multiparagraph instruction11	Initial value	0.0%
	Set the scope	-100.0%~100.0%	
PC-12	Multiparagraph instruction12	Initial value	0.0%
	Set the scope	-100.0%~100.0%	
PC-13	Multiparagraph instruction13	Initial value	0.0%
	Set the scope	-100.0%~100.0%	
PC-14	Multiparagraph instruction14	Initial value	0.0%
	Set the scope	-100.0%~100.0%	
PC-15	Multiparagraph instruction15	Initial value	0.0%
	Set the scope	-100.0%~100.0%	

Multiple instructions can be used in three occasions: as a frequency source, as a voltage source for V/F separation, and as a setting source for the process PID.three.

In the application situations, the magnitude of multiple segment instructions is the relative value, with the range of-100.0%~100.0%, when it is used as the frequency source Is the percentage, relative to the maximum frequency; and that is relative, when it is used as the V / F separation voltage source; and because Given the PID is the relative value, the multisegment instruction as the PID setting source does not require the dimensional conversion.

Multi-segment instructions need to be selected according to the different states of the multi-function DI digital input terminal. For details, please refer to the relevant instructions of the P4 group.

PC-16	Simple PLC operation mode		Initial value	0
	Set the scope	0	End of a single operation of shutdown	
		1	The final value is maintained at the end of a single run	
		2	Has been a cycle	

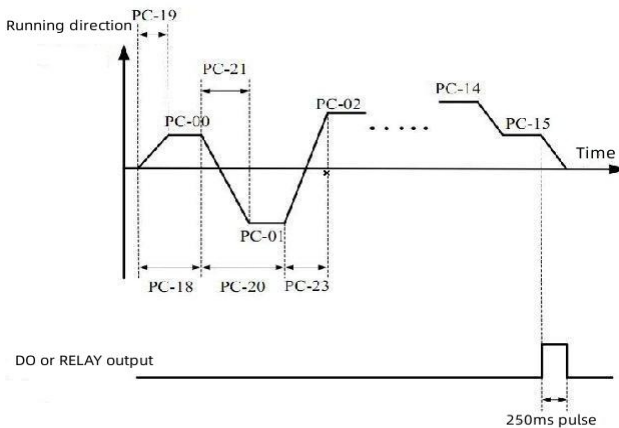

As a frequency source, the PLC has three operating modes, which are not available as a V / F separation voltage source.among:

0: End of single run shutdown The drive stops automatically after completing a single cycle, and the running command needs to be given again to start.

1: Keep the final value of the drive after a single cycle, automatically maintain the running frequency and direction of the last segment.

2: After one cycle, the cycle drive automatically starts the next cycle until there is a stop command.

PC-17	Simple PLC power memory selection	Initial value	00
	Set the scope	the unit	Descent memory choice
		0	Don't remember when you drop electricity
		1	The electricity memory
		tens digit	Downtime memory choice
		0	Stop time without memory
1		Downtime memory	

PLC power loss memory refers to the operation stage and frequency of PLC before power loss, and continues to run from the memory stage the next time. Choose not to remember, and the PLC process is restarted each time.

PC-18	Simple PLC paragraph 0 run time	Initial value	0.0s (h)
	Set the scope	0.0s (h) ~6553.5s (h)	
PC-19	Simple PLC paragraph 0 acceleration and deceleration time	Initial value	0
	Set the scope	0~3	
PC-20	Easy PLC paragraph 1 run time	Initial value	0.0s (h)
	Set the scope	0.0s (h) ~6553.5s (h)	
PC-21	Simple PLC paragraph 1 acceleration and deceleration time	Initial value	0
	Set the scope	0~3	
PC-22	Easy PLC paragraph 2 run time	Initial value	0.0s (h)
	Set the scope	0.0s (h) ~6553.5s (h)	
PC-23	Simple PLC paragraph 2 acceleration and deceleration time	Initial value	0
	Set the scope	0~3	
PC-24	Simple PLC paragraph 3 run time	Initial value	0.0s (h)
	Set the scope	0.0s (h) ~6553.5s (h)	
PC-25	Simple PLC paragraph 3 acceleration and deceleration time	Initial value	0
	Set the scope	0~3	
PC-26	Simple PLC paragraph 4 run time	Initial value	0.0s (h)
	Set the scope	0.0s (h) ~6553.5s (h)	
PC-27	Simple PLC paragraph 4 acceleration and deceleration time	Initial value	0
	Set the scope	0~3	

P
L
C
s
h
u
t
d
o
w
n
m
e
m
o
r
y
i
s
t

o record the operation stage and operation frequency of the previous PLC, and continue to run from the memory stage in the next operation. Choose not to remember, and the PLC process is restarted with each start.

PC-28	Easy PLC paragraph 5 run time	Initial value	0.0s (h)
	Set the scope	0.0s (h) ~6553.5s (h)	
PC-29	Simple PLC paragraph 5 acceleration and deceleration time	Initial value	0
	Set the scope	0~3	
PC-30	Simple PLC paragraph 6 run time	Initial value	0.0s (h)
	Set the scope	0.0s (h) ~6553.5s (h)	
PC-31	Simple PLC paragraph 6 acceleration and deceleration time	Initial value	0
	Set the scope	0~3	
PC-32	Simple PLC paragraph 7 run time	Initial value	0.0s (h)
	Set the scope	0.0s (h) ~6553.5s (h)	
PC-33	Simple PLC paragraph 7 acceleration and deceleration time	Initial value	0
	Set the scope	0~3	
PC-34	Simple PLC paragraph 8 run time	Initial value	0.0s (h)
	Set the scope	0.0s (h) ~6553.5s (h)	
PC-35	Simple PLC paragraph 8 acceleration and deceleration time	Initial value	0
	Set the scope	0~3	
PC-36	Simple PLC paragraph 9 run time	Initial value	0.0s (h)
	Set the scope	0.0s (h) ~6553.5s (h)	
PC-37	Simple PLC paragraph 9 acceleration and deceleration time	Initial value	0
	Set the scope	0~3	
PC-38	Easy PLC paragraph 10 run time	Initial value	0.0s (h)
	Set the scope	0.0 s (h) ~6553.5s (h)	
PC-39	Simple PLC paragraph 10 of acceleration and deceleration time	Initial value	0

	Set the scope	0~3	
PC-40	Easy PLC paragraph 11 run time	Initial value	0.0s (h)
	Set the scope	0.0s (h) ~6553.5s (h)	
PC-41	Simple PLC paragraph 11 of acceleration and deceleration time	Initial value	0
	Set the scope	0~3	
PC-42	Simple PLC paragraph 12 run time	Initial value	0.0s (h)
	Set the scope	0.0s (h) ~6553.5s (h)	
PC-43	Simple PLC paragraph 12 of acceleration and deceleration time	Initial value	0
	Set the scope	0~3	
PC-44	Simple PLC paragraph 13 run time	Initial value	0.0s (h)
	Set the scope	0.0s (h) ~6553.5s (h)	

PC-45	Simple PLC paragraph 13	Initial value	0
	Set the scope	0~3	
PC-46	Simple PLC paragraph 14 run time	Initial value	0.0s (h)
	Set the scope	0.0s (h) ~6553.5s (h)	
PC-47	Simple PLC paragraph 14	Initial value	0
	Set the scope	0~3	
PC-48	Simple PLC paragraph 15 run time	Initial value	0.0s (h)
	Set the scope	0.0s (h) ~6553.5s (h)	
PC-49	Simple PLC paragraph 15	Initial value	0
	Set the scope	0~3	
PC-50	Simple PLC running time unit	Initial value	0
		0	S(second)

	Set the scope	1	h(hour)
PC-51	Multi-paragraph instruction 0 given way	Initial value	0
	Set the scope	0	Function code PC-00 is given
		1	A1
		2	A12
		3	A13
		4	pulse impulse

		5	PID
		6	Given the preset frequency (P0-08), UP / DOWN can be modified

This parameter determines the given channel for multisegment instruction 0.

In addition to the PC-00, there are a variety of other options to easily switch between multiple short instructions and other given modes. When multiple-segment instructions serve as the frequency source or simple PLC serve as the frequency source, the switching of the two frequency sources can be easily realized.

PD group communication parameters

Please refer to Appendix V: Modbuscommunication protocol

PE group user custom function code

PE-00	User function code0	Initial value	P0.00
	Set the scope	P0.00~PP.xx, H0.00~Ax.xx, U0.xx	
PE-01	User function code1	Initial value	P0.02
	Set the scope	same asPE-00	
PE-02	User function code2	Initial value	P0.03
	Set the scope	same asPE-00	
PE-03	User function code3	Initial value	P0.07
	Set the scope	same asPE-00	
PE-04	User function code4	Initial value	P0.08
	Set the scope	same asPE-00	
PE-05	User function code5	Initial value	P0.17
	Set the scope	same asPE-00	
PE-06	User function code6	Initial value	P0.18
	Set the scope	same asPE-00	
PE-07	User function code7	Initial value	P3.00
	Set the scope	same asPE-00	
PE-08	User function code8	Initial value	P3.01
	Set the scope	same asPE-00	
PE-09	User function code9	Initial value	P4.00
	Set the scope	same asPE-00	
PE-10	User function code10	Initial value	P4.01

	Set the scope	same asPE-00	
PE-11	User function code11	Initial value	P4.02
	Set the scope	same asPE-00	
PE-12	User function code12	Initial value	P5.04
	Set the scope	same asPE-00	
PE-13	User function code13	Initial value	P5.07
	Set the scope	same asPE-00	
PE-14	User function code14	Initial value	P6.00
	Set the scope	same asPE-00	
PE-15	User function code15	Initial value	P6.10
	Set the scope	same asPE-00	
PE-16	User function code16	Initial value	P0.00
	Set the scope	same asPE-00	
PE-17	User function code17	Initial value	P0.00
	Set the scope	same asPE-00	
PE-18	User function code18	Initial value	P0.00
	Set the scope	same asPE-00	
PE-19	User function code19	Initial value	P0.00
	Set the scope	same asPE-00	
PE-20	User function code20	Initial value	P0.00
	Set the scope	same asPE-00	
PE-21	User function code21	Initial value	P0.00
	Set the scope	same asPE-00	
PE-22	User function code22	Initial value	P0.00
	Set the scope	same asPE-00	
PE-23	User function code23	Initial value	P0.00
	Set the scope	same asPE-00	
PE-24	User function code24	Initial value	P0.00
	Set the scope	same asPE-00	
PE-25	User function code25	Initial value	P0.00
	Set the scope	same asPE-00	
PE-26	User function code26	Initial value	P0.00
	Set the scope	same asPE-00	
PE-27	User function code27	Initial value	P0.00
	Set the scope	same asPE-00	
PE-28	User function code28	Initial value	P0.00
	Set the scope	same asPE-00	
PE-29	User function code29	Initial value	P0.00
	Set the scope	same asPE-00	

This set of function codes is a user-customized parameter group.

In all function codes, the user can select the required parameters summarized to the PE group by the user to facilitate viewing and change.

PE group provides a maximum of 30 user-customized parameters, and the PE group parameter display value of P0.00 indicates that the User function code is empty. When entering the user customization parameter mode, the display function code is defined by PE-00~PE-31, the order is consistent with the PE group function code, P0-00-skip

PP group function code management

PP-00	User password	Initial value	0
	Set the scope	0~65535	

PP-00 sets any non-zero number, then the password protection function takes effect. The next time you enter the menu, you must enter the password correctly, otherwise you cannot view and modify the function parameters. Please remember the set user password

Set PP-00 to 00000, then clear the set user password to make the password protection function invalid.

PP-01	Parameter initialization	Initial value	0
	Set the scope	0	no-operation
		1	Restore the factory parameters, excluding the motor parameters
		2	Clear record information
		4	Restore the user backup parameters
		501	Backup the user of the current parameter

1. Return to the factory setting value, excluding the motor parameters

After setting PP-01 to 1, most of the driver functional parameters are restored to the factory parameters, but the motor parameters, frequency command decimal point (P0-22), fault record information, cumulative running time (P7-09), cumulative power time (P7-13), and cumulative power consumption (P7-14) are not restored.

2. Clear the record information

Clear drive fault record information, cumulative running time (P7-09), cumulative power on time (P7-13), cumulative power consumption (P7-14).

3. Backup the user's current parameters

Backup of the parameters set by the current user. Backup the setting values for all of the current function parameters. To facilitate the customer to recover after parameter adjustment.

4. Restore the user backup parameters

Restore the user parameter, namely the backup parameter by setting PP-01 to 501.

PP-02	Functional parameter mode display properties		Initial value	11
	Set the scope	the unit	Group U shows selection	
		0	blank	
		1	display	
		tens digit	Group A shows selection	
		0	blank	
		1	display	
PP-03	Personality parameter mode display selection		Initial value	00
	Set the scope	the unit	User-customized parameter display selection	
		0	blank	
		1	display	
		tens digit	User change parameter display selection	
		0	blank	
1		display		

The establishment of the parameter display mode is mainly to facilitate users to view the functional parameters in the form of no same as arrangement according to their actual needs, and to provide three parameter display modes.

FC	Description
Functional parameter mode	Order to display the drive function parameters, including P 0 ~ P, H0~AP, U0~UP function parameter groups
User customization parameter mode	The user customize the individual functional parameters displayed (up to 32), and the user determines the need to display the functional parameters through PE group
User changes the parameter mode	Functional parameters that are inconsistent with the factory parameters

When the personality parameter display selection (PP-03) is a display, you can switch to the parameter display without same as through JOG / QUICK key, and the default value is only functional parameter display Each parameter display mode is encoded as:

Parameter display	Display
Functional parameter mode	-BASE
User customization parameter mode	-USER
User changes the parameter mode	--C--

The drive provides two sets of personalized parameters display mode: user customization parameter mode, user change parameter mode. User customized parameter group parameters set by the user to the PE group for the user, a maximum of 32 parameters can be selected, these parameters are summarized together, which can facilitate customer debugging.

Under the user customization parameter mode, a symbol is added by default before the user customized function code u. For example, P1-00, under the user customized parameter mode, the display effect is uP1-00 for the user to change the parameter mode, and for the user to change the parameter that is not same as with the manufacturer Initial value. User change parameter group helps customers to view the changed parameter summary and facilitate the problem search on the spot.

Under user changes parameter mode, a symbol c is added by default before the function code customized by the user.

PP-04	The function code modifies the properties		Initial value	0
	Set the scope	0	Revisability	
		1	Do not modify	

The user sets whether the function code parameters can be modified to prevent the risk of the function parameters being mistakenly changed.

If the function code is set to 0, all function codes can be modified; when set to 1, all function codes can only be viewed and cannot be modified.

PP-05	Model setting	1: G type machine 2: P type machine	1	★
-------	---------------	--	---	---

For G / P-integrated model, users can set the drive in G or P mode through this parameter. After changing this parameter, the display value of parameter P0-00 will be modified accordingly.

For a same as drive, the rated power after changing to the P type state will be one gear larger than that of the working G type state. Therefore, after modifying this parameter, the parameters related to the drive power and motor power will be automatically changed.

H0 set of torque control and limit parameters

H0-00	Speed / torque control mode selection		Initial value	0
	Set the scope	0	speed control	
		1	torque control	

For selecting the drive control mode: speed control or torque control.

Multifunctional DI digital input terminal has two functions related to torque control: torque control Prohibit (function 29), speed control / torque control switch (function 46). These two terminals should be used with H0-00 to switch between speed and torque control.

When the speed control / torque control switch terminal invalid, the control mode is

determined by H0-00. If the speed control / torque control switch effective, the control mode is equivalent to the value of H0-00.

In any case, when the torque control Prohibit terminal effective, the drive is fixed to the speed control mode.

H0-01	Torque control mode under the torque setting source selection		Initial value	0
	Set the scope	0	Number setting (H0-03)	
		1	AI1	
		2	AI2	
		3	AI3	
		4	PULSE impulse	
		5	Communication Given	
		6	MIN (AI1,AI2)	
7	MAX (AI1,AI2)			
H0-03	Torque number setting under the torque control mode		Initial value	0
	Set the scope		-200.0%~200.0%	

H0-01 is used to select the torque setting source, with all 8 medium torque setting modes.

Set the relative value, 100.0% corresponds to the rated torque of the drive. Set the scope-200.0%~200.0%, indicating that the maximum torque of the frequency converter is 2 times the rated torque of the driver. When the torque setting is adopted in mode 1~7, 100% of communication, analog input and pulse input correspond to H0-03.

H0-05	Torque controls the forward maximum frequency	Initial value	50.00Hz
	Set the scope	0.00Hz~ the maximum frequency (P0-10)	
H0-06	Torque controls the reverse maximum frequency	Initial value	50.00Hz
	Set the scope	0.00Hz~ the maximum frequency (P0-10)	

Used to set the forward or reverse maximum operating frequency of the drive in the torque control mode.

When the drive torque is controlled, if the load torque is less than the output torque of the motor, the motor speed will continue to rise, and in order to prevent the mechanical system from flying accidents, the maximum speed of the motor during the torque control must be limited.

H0-07	Torque to control the acceleration time		Initial value	0.00s
	Set the scope	0.00s~65000s		
H0-08	Torque-controlled deceleration time		Initial value	0.00s
	Set the scope	0.00s~65000s		

Under the torque control mode, the difference between the output torque of the motor and the load torque determines the change rate of change of the motor and the load. Therefore, the motor speed may change rapidly, causing problems such as noise or excessive mechanical stress. By setting the torque to control the acceleration and deceleration time, the motor speed can change gently.

However, for cases where rapid torque response is required, the torque control acceleration and deceleration time is required to be 0.00s.

For example: two motor hard connection drag same as a load, to ensure uniform load distribution, set a drive for the host, using speed control, the other drive for slave and using torque control, the actual output torque as the slave torque instructions, the slave torque need to quickly follow the host, then the slave torque control acceleration and deceleration time of 0.00s.

H1 group of virtual DI input terminal, virtual DO

H1-00	Virtual VDI 1 terminal function selection		Initial value	0
	Set the scope	0~59		
H1-01	Virtual VDI 2 terminal function selection		Initial value	0
	Set the scope	0~59		
H1-02	Virtual VDI 3 terminal function selection		Initial value	0
	Set the scope	0~59		
H1-03	Virtual VDI 4 terminal function selection		Initial value	0
	Set the scope	0~59		
H1-04	Virtual VDI 5 terminal function selection		Initial value	0
	Set the scope	0~59		

In terms of function, the virtual VDI 1 ~ VDI 5 is completely in phase same as with the DI digital input terminal on the control board, which can be used as a multi-function digital quantity input. Please refer to P4-00~P4-09 for detailed setting.

H1-05	Virtual VS terminal effective state setting mode		Initial value	00000
	Set the scope	the unit	Virtual VDI1	
		0	The status of the virtual VDOx determines whether the VS is a effective	
		1	Set whether the VS is effective by the function code H1-06	
		tens digit	Virtual VDI 2 (0~1, ditto)	
		hundred digits	Virtual VDI 3 (0~1, ditto)	
		kilobit	Virtual VDI 4 (0~1, ditto)	
myriabit	Virtual VDI 5 (0~1, ditto)			
H1-06	Virtual VS terminal status setting		Initial value	00000
	Set the scope	the unit	Virtual VDI1	
		0	invalid	
		1	effective	
		tens digit	Virtual VDI 2 (0~1, ditto)	
		hundred digits	Virtual VDI 3 (0~1, ditto)	
		kilobit	Virtual VDI 4 (0~1, ditto)	
myriabit	Virtual VDI 5 (0~1, ditto)			

Unlike the ordinary digital quantity input terminal, the state of the virtual VS can be set in two ways and selected by H1-05. When the selected VS state is determined by the state of the corresponding virtual VDO, whether the VS is in the effective state, depending on the VDO output is effective or invalid, and the VSx is uniquely bound to the VDOx (x is 1 to 5).

When the VS state is selected and set by the function code, the state of the virtual input terminal is each determined, by the binary bits of the function code H1-06. The following are some examples of how to use the virtual VDI. Example 1: When the VDO status is selected to determine the VDI status, the following functions are completed: "When the AI1 input exceeds the upper and lower limit, the drive fault alarms and stops". The following setting method can be adopted:

The function of setting VDI 1 is "User custom fault 1" (H1-00=44); set the effective status mode of VDI 1 terminal VDO 1 determination (H1-05 = xxx 0); setting VDO 1 output function is "AI1 input exceeds the upper and lower limits" (H1-11=31);

When the time of AI1 input exceeds the upper limit, the output of VDO 1 is in ON state, and the state of VDI 1 input terminal is effective and the frequency converter VDI 1 receives user custom fault 1, the drive will fault alarm Err 27 and stop.

Example 2: When the function code H1-06 is selected to set the VS status, to complete the following functions: "After the drive is powered, automatically enter the running state", the following setting method can be adopted:

Set the function of VDI 1 to "positive Run" (H1-00=1); set the status mode of terminal effective of VDI 1 to set by the function code (H1-05 = xxx 1); set the terminal status of VDI 1 to effective (H1-06 = xxx 1); set the command source to "Terminal Control" (P0-02=1); set the startup protection selection as "not protected" (P8-18=0);

After the drive is initialized, the VDI 1 is detected as effective, and the terminal corresponds to the positive operation, which is equivalent to the drive receiving a terminal positive running command, and the drive immediately starts the positive operation.

H1-07	Functional selection of AI1 terminals as DI input terminals		Initial value	0
	Set the scope		0~59	
H1-08	Functional selection of AI2 terminals as DI input terminals		Initial value	0
	Set the scope		0~59	
H1-09	Functional selection of AI3 terminals as DI input terminals		Initial value	0
	Set the scope		0~59	
H1-10	The effective mode selection with the analog quantity input as the DI input terminal		Initial value	000
	Set the scope	the unit	A1	
		0	High-level, effective	
		1	Level of the effective	
		hundred digits	AI2 (0~1, same as the unit)	
	kilobit	AI3 (0~1, same as the unit)		

This set of functional codes is used to use the analog input as DI input terminal. When the analog input is used as DI input terminal, and the analog input voltage is greater than 7V, the analog input terminal state is high level; When the analog input voltage is lower than 3V, the analog input terminal state is low level. The hysteresis loop is found between 3 V and 7 V.

H1-10 is used to determine whether the analog input is the high level or the effective state for the analog input as the DI input terminal. As for the function setting of the analog quantity input as the DI input terminal, phase same as with the normal DI input terminal setting, please refer to the description of the relevant DI input terminal setting of the P4 group.

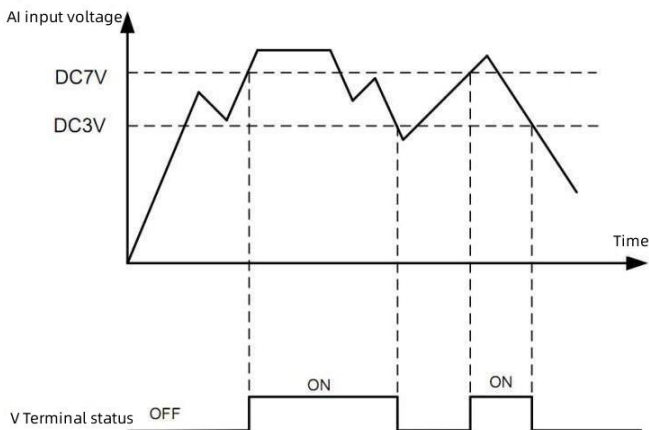

Simog input terminal effective state judgment

H1-11	Virtual VDO 1 output function selection		Initial value	0
	Set the scope		0: an internal short contact with the Sx input terminal on the PCB 1~40: See DO output terminal selection for Group P5	
H1-12	Virtual VDO 2 output function selection		Initial value	0
	Set the scope		0: an internal short contact with the Sx input terminal on the PCB 1~40: See DO output terminal selection for Group P5	
H1-13	Virtual VDO 3 output function selection		Initial value	0
	Set the scope		0: an internal short contact with the Sx input terminal on the PCB 1~40: See DO output terminal selection for Group P5	
H1-14	Virtual VDO 4 output function selection		Initial value	0
	Set the scope		0: an internal short contact with the Sx input terminal on the PCB 1~40: See DO output terminal selection for Group P5	
H1-15	Virtual VDO 5 output function selection		Initial value	0
	Set the scope		0: an internal short contact with the Sx input terminal on the PCB 1~40: See DO output terminal selection for Group P5	
H1-16	VDO 1 output delay time		Initial value	0.0s
	Set the scope		0.0s~3600.0s	
H1-17	VDO 2 output delay time		Initial value	0.0s
	Set the scope		0.0s~3600.0s	
H1-18	VDO 3 output delay time		Initial value	0.0s
	Set the scope		0.0s~3600.0s	
H1-19	VDO 4 output delay time		Initial value	0.0s
	Set the scope		0.0s~3600.0s	
H1-20	VDO 5 output delay time		Initial value	0.0s
	Set the scope		0.0s~3600.0s	
H1-21	VDO output terminal effective status selection		Initial value	00000
	Set the scope	the unit	VDO1	
		0	positive logic	
		1	antilogical	
		tens digit	VDO2 (0~1, same as the unit)	
		hundred digits	VDO3 (0~1, same as the unit)	
		kilobit	VDO4 (0~1, same as the unit)	
myriabit	VDO5 (0~1, same as the unit)			

The virtual digital quantity output function, similar to the control board DO output function, can be used to cooperate with the virtual digital quantity input VSx to realize some simple logical control.

When the virtual VDOx output function is selected as 0, the output state of VDO 1 to VDO 5 is determined by the state of DI 1 to DI 5 input on the control board, and VDOx and Sx correspond one by one.

H2-00	Motor type selection		Initial value	0
	Set the scope	0	Ordinary asynchronous motor	
		1	Frequency conversion asynchronous motor	
H2-01	Power rating		Initial value	Model determination
	Set the scope		0.1kW~1000.0kW	
H2-02	Rated voltage		Initial value	Model determination
	Set the scope		1V~2000V	
H2-03	Rated current		Initial value	Model determination
	Set the scope		0.01A~655.35A (Drive power <=55kW) 0.1A~6553.5A (Drive power> 55kW)	
H2-04	Rated frequency		Initial value	Model determination
	Set the scope		0.01Hz~ the maximum frequency	
H2-05	Rated speed		Initial value	Model determination
	Set the scope		1rpm~65535rpm	
H2-06	Asynchronous motor stator resistance		Initial value	Model determination
	Set the scope		0.001 Ω ~65.535 Ω (drive power <=55kW) 0.0001 Ω ~6.5535 Ω (Drive power> 55kW)	
H2-07	Asynchronous motor rotor resistance		Initial value	Model determination
	Set the scope		0.001 Ω ~65.535 Ω (drive power <=55kW) 0.0001 Ω ~6.5535 Ω (Drive power> 55kW)	
H2-08	Leakage resistance of Asynchronous motor		Initial value	Model determination
	Set the scope		0.01mH~655.35mH (Drive power <=55kW) 0.001mH~65.535mH (Drive power> 55kW)	
H2-09	Mutual inductive resistance of Asynchronous motor		Initial value	Model determination
	Set the scope		0.1mH~6553.5mH (Drive power <=55kW) 0.01mH~655.35mH (Drive power> 55kW)	
H2-10	No-load current of Asynchronous motor		Initial value	Model determination
	Set the scope		0.01A~H2-03 (Drive power <=55kW) 0.1A~H2-03 (Drive power> 55kW)	
H2-27	Number of encoder lines		Initial value	1024
	Set the scope		1~65535	
H2-28	Encoder type		Initial value	0
	Set the scope	0	ABZ incremental encoder	

		1	UVW incremental encoder
		2	Rotary transformer
		3	Positive cosine encoder
		4	Provincial line mode UVW encoder
H2-29	Speed to give feedback to the PG selection	Initial value	0
	Set the scope	0	This locality PG
		1	Expand PG
		2	PULSE Pulse input (DI5)
H2-30	ABZ incremental encoder AB phase sequence	Initial value	0
	Set the scope	0	forward direction
		1	opposite direction
H2-31	Encoder installation angle	Initial value	0
	Set the scope	0.0°~359.9°	
H2-32	UVW encoder has a UVW phase sequence	Initial value	0
	Set the scope	0	forward direction
		1	opposite direction
H2-33	UVW encoder bias angle	Initial value	0.0°
	Set the scope	0.0°~359.9°	
H2-34	Rotary transformer pole-log	Initial value	1
	Set the scope	1~65535	
H2-36	Speed feedback PG break detection time	Initial value	0.0s
	Set the scope	0.0: No action 0.1s~10.0s	
H2-37	Tune selection		Initial value 0
	Set the scope	0	no-operation
		1	Asynchronous static tuning
		2	Complete tuning of the asynchronous machine
		11	Synchronizer static tuning
	12	Synchronizer with complete tuning	
H2-38	The velocity-ring proportional gain of 1	Initial value	30
	Set the scope	1~100	
H2-39	The velocity loop integration time of 1	Initial value	0.50s
	Set the scope	0.01s~10.00s	

H2-40	Switch frequency 1	Initial value	5.00Hz	
	Set the scope	0.00~H2-43		
H2-41	The velocity-loop proportional gain of 2	Initial value	15	
	Set the scope	0~100		
H2-42	The velocity loop integration time 2	Initial value	1.00s	
	Set the scope	0.01s~10.00s		
H2-43	Switch frequency 2	Initial value	10.00Hz	
	Set the scope	H2-40 to the maximum output frequency		
H2-44	Vector-controlled turn-difference gain	Initial value	100%	
	Set the scope	50%~200%		
H2-45	The velocity loop filtering time constant	Initial value	0.050s	
	Set the scope	0.000s~0.100s		
H2-46	Vector-controlled overexcitation gain	Initial value	64	
	Set the scope	0~200		
H2-47	Torque upper limit source under speed control mode	Initial value	0	
	Set the scope	0	H2-48 setting	
		1	AI1	
		2	AI2	
		3	AI3	
		4	PULSE setting	
		5	Communication setting	
		6	MIN (AI1,AI2)	
7	MAX (AI1,AI2)			
H2-48	Set the torque upper limit number in the speed control mode	Initial value	150.0%	
	Set the scope	0.0%~200.0%		
H2-51	Excitation regulation proportional gain	Initial value	2000	
	Set the scope	0~20000		
H2-52	Excitation regulation of integral gain	Initial value	1300	
	Set the scope	0~20000		
H2-53	Torque regulation proportional gain	Initial value	2000	
	Set the scope	0~20000		
H2-54	Torque adjustment integral gain	Initial value	1300	
	Set the scope	0~20000		
	The velocity loop integral property	Initial value	0	

H2-55	Set the scope		the unit: Integration and separation 0: invalid 1: effective	
H2-61	2nd Motor control mode		Initial value	2
	Set the scope	2	V/F control	
H2-62	2nd motor acceleration and deceleration time selection		Initial value	0
	Set the scope	0	Same as for the first electric motor	
		1	Add deceleration time 1	
		2	Add deceleration time 2	
		3	Add deceleration time 3	
	4	Add deceleration time 4		
H2-63	2nd motor torque lift		Initial value	Model determination
	Set the scope		0.0%: Automatic torque lift 0.1%~30.0%	
H2-65	Second motor oscillation suppression gain		Initial value	Model determination
	Set the scope		0~100	

H5 group controls the optimization parameters

H5-00	DPWM	Initial	12.00Hz
	Set the scope		0.00Hz~15Hz

Control the effective only for V / F. The wave mode of asynchronous V / F is determined, lower than this value is 7-segment continuous modulation mode, On the contrary, it is a 5-segment intermittent modulation mode

In the 7-segment continuous modulation, the switching loss of the driver is large, but the current ripple is small; in the 5 segment, the current loss is small; but the motor operation may be unstable at high frequency, and no modification is required.

Refer to function code P3-11 for V / F operating instability, and function code P0-15 for driver loss and temperature rise;

H5-01	PWM modulation mode		Initial value	0
	Set the scope	0	Asynchronous modulation	
		1	isochronous modulation	

Control the effective only for V / F.same as Step modulation, refers to the carrier frequency changes linearly with the output frequency transformation, to ensure the ratio of the two (Carrier ratio) unchanged, generally used when the output frequency is high,

is conducive to the output voltage quality.

At lower output frequencies (below 100Hz), same as-step modulation is generally not required, because the ratio of carrier frequency to output frequency is higher at this time,

and the advantage of asynchronous modulation is more obvious.

When the operating frequency is above 85Hz, same as step modulation, the frequency below fixed for asynchronous modulation.

H5-02	Selection of dead zone compensation mode		Initial value	1
	Set the scope	0	No compensation	
		1	Compensation mode 1	
		2	Compensation mode 2	

This parameter generally does not need to be modified, only in the quality of the output voltage wave form has special requirements, or the motor oscillation is abnormal, need to try to switch to choose a different compensation mode.

High power is recommended to use the compensation mode 2.

H5-03	Random PWM depth		Initial value	0
	Set the scope	0	PWM invalid	
		1~10	PWM carrier frequency random depth	

Set the random PWM, can make the monotonous harsh motor sound become relatively soft, and can be conducive to reduce the external electromagnetic interference. When the random PWM depth was set to 0, the random PWM invalid. Adjusting the random PWM for different depths will give different effects

H5-04	Fast flow limiting enabling		Initial value	1
	Set the scope	0	Do not make	
		1	enable	

Enable the fast flow limiting function to minimize the overflow fault of the drive and ensure the uninterrupted operation of the drive. If the drive is in a fast flow limiting state for a long time, the drive may appear overheating and other damage, which is not Aallow.

H5-05		Initial value	
	Set the scope	0~100	

Use to set the current detection compensation of the driver, too large setting may lead to decreased control performance. Generally does not require modification.

H5-06		Initial value	350
	Set the scope	200~450	

For setting the voltage value of Err 09, the drive voltage level with no same as voltage level are respectively:

Single-phase 220V or three-phase 220V: 200V three-phase 380V:

350V three-phase 480V: 450V

H5-07	SVC-optimized mode selection		Initial value	1
	Set the scope	0	Unoptimized	
		1	Optimization mode 1	
		2	Optimization mode 2	

Optimization mode 1: used with high torque control linearity requirements.

Optimization mode 2: Use it when having high speed and stability requirements.

H5-08	Time adjustment of dead zone	Initial value	150%
	Set the scope	100%~200%	

For the 1140V voltage level setting. Adjusting this value can improve the utilization rate of voltage effective, and adjusting too small can easily lead to unstable system operation. User modification is not recommended.

H6 group analog quantity input curve setting

H6-00	Analog quantity input curve 4 minimum input	Initial value	0.00V
	Set the scope	-10.00V~H6-02	
H6-01	Analog input curve 4 minimum input corresponding setting	Initial value	0.0%
	Set the scope	-100.0%~100.0%	
H6-02	Analog quantity input curve 4 inflection point 1 input	Initial value	3.00V
	Set the scope	H6-00~H6-04	

H6-03	Simog input curve 4 inflection point 1 input corresponding setting	Initial value	30.0%
	Set the scope	-100.0%~100.0%	
H6-04	Analog quantity input curve 4 inflection point 2 input	Initial value	6.00V
	Set the scope	H6-02 ~H6-06	
H6-05	Simog input curve 4 inflection point 2 input corresponding setting	Initial value	60.0%
	Set the scope	-100.0%~100.0%	
H6-06	Analog quantity input curve 4 maximum input	Initial value	10.00V
	Set the scope	H6-06 ~10.00V	
H6-07	Analog input curve 4 The maximum input corresponds to the setting	Initial value	100.0%
	Set the scope	-100.0%~100.0%	
H6-08	Analog quantity input curve 4 minimum input	Initial value	0.00V
	175		
	Set the scope	-10.00V~H6-10	
H6-09	Analog input curve 5 minimum input corresponds to the setting	Initial value	0.0%
	Set the scope	-100.0%~100.0%	
H6-10	Analog quantity input curve 5 inflection point 1 input	Initial value	3.00V
	Set the scope	H6-08 ~H6-12	
H6-11	Simog input curve 5 inflection point 1 input corresponding setting	Initial value	30.0%
	Set the scope	-100.0%~100.0%	
H6-12	Analog quantity input curve 5 inflection point 2 input	Initial value	6.00V
	Set the scope	H6-10 ~H6-14	
H6-13	Simog input curve 5 inflection point 2 input corresponding setting	Initial value	60.0%
	Set the scope	-100.0%~100.0%	
H6-14	Analog quantity input curve 5 maximum input	Initial value	10.00V
	Set the scope	H6-14 ~10.00V	
H6-15	Analog input curve 5 maximum input corresponding setting	Initial value	100.0%
	Set the scope	-100.0%~100.0%	

Curves 4 and 5 function similar to curves 1 to 3, but curves 1 to 3 are straight lines, while curves 4 and 5 are 4-point curves, which enables a more flexible correspondence. The following figure shows the schematic diagram of curve 4 to curve 5.

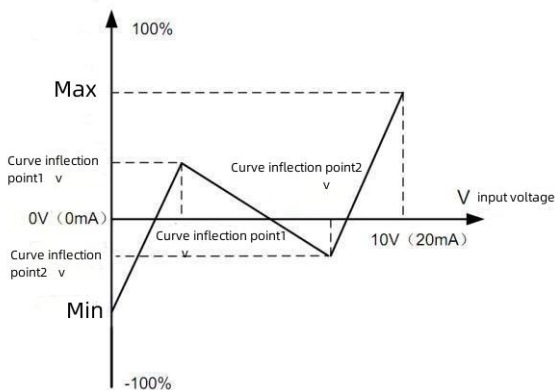

Schematic representation of curves 4 and 5

When setting curve 4 and curve 5, it should be noted that the minimum input voltage, inflection point 1 voltage, inflection point 2 voltage and maximum voltage of the curve must be increased successively.

The analog input curve selection P was used to determine how the analog input AI 1 to AI 3 were selected among the five curves.

H6-16	AI1 sets the jump point	Initial value	0.0%
	Set the scope	-100.0%~100.0%	
H6-17	AI1 sets the jump amplitude	Initial value	0.5%
H6-18	AI2 sets the jump point	Initial value	0.0%
	Set the scope	-100.0%~100.0%	
H6-19	AI2 sets the jump amplitude	Initial value	0.5%
	Set the scope	0.0%~100.0%	
H6-20	AI3 sets the jump point	Initial value	0.0%
	Set the scope	-100.0%~100.0%	
H6-21	AI2 sets the jump amplitude	Initial value	0.5%
	Set the scope	0.0%~100.0%	

Analog input AI1~AI3, both have the set value jump function.

The jump function means that when the simulated amount is set corresponding to the upper and lower interval of the jump point, the corresponding set value is fixed to the value of the jump point.

For example, if the voltage of the analog input AI1 fluctuates around 5.00V, the

fluctuation range is 4.90V~5.10V, the minimum input of AI10.00V corresponds to 0.0%, and the maximum input 10.00V corresponds to 100.%, then the detected AI1 is set to fluctuate between 49.0% and 51.0%.

Set the jump point of AI1 H6-16 to 50.0%, and the jump amplitude H6-17 of AI1 is set to 1.0%. After the above AI1 input, the resulting AI1 input is fixed to 50.0%, and AI1 is converted into a stable input, eliminating the fluctuation.3

The dormant awake functional parameters in the H9 group

This group of parameters are mainly used to realize the dormancy and wake function in constant pressure water supply application

H9-00	The sleep wake-up function is turned on	Scope: 0~1	Initial value: 0
-------	---	------------	------------------

0: Dormant wake-up function invalid

1: Turn on dormancy mode according to pressure and frequency.

Note: The drive frequency source P0-03 is automatically switched to PID, PA-00 is automatically switched to AI1 as the feedback pressure, PA-28 automatically changes to 1 shutdown PID operation, the given source of the PID is not controlled by PA-00 and automatically switches to H9-05, the digital tube 1 automatically displays the given water pressure (H9-05), and the digital tube 2 automatically displays the feedback water pressure (percentage of feedback source selected by PA-02 * range H9-06).

H9-01	The dormancy frequency	Range: 0.00Hz~50.00Hz	Initial value: 20.00Hz
-------	------------------------	-----------------------	------------------------

H9-00=1 hibernation function takes effect. When the drive runs, the feedback pressure is higher than the set pressure H9-05-hibernation pressure deviation H9-07, exceeds the hibernation delay time H9-02, and the operation frequency is lower than the hibernation frequency H9-01, the drive starts sleep (stop) and enters the hibernation state.

H9-02	Sleep delay time	Scope: 0.0s~3600.0s	Initial value: 5.0s
-------	------------------	---------------------	---------------------

Set the dormancy delay time and use with H9-01.

H9-03	Percent of wake-up stress	Scope: 0.0%~100.0%	Initial value: 60.0%
-------	---------------------------	--------------------	----------------------

This parameter takes the set pressure as the reference object, namely, the set pressure is 100%;

After the drive enters the dormant state, the feedback pressure is lower than the set pressure H9-05 * wake up pressure H90-03. After the wake up delay H9-04, the wake up is

successful and the driver returns to the PID regulator.

Excessive H9-03 setting may cause frequent drive start and stop, and

too low setting may lead to insufficient pressure.

H9-04	Wake up delay	Scope: 0.0s~3600.0s	Initial value: 3.0s
-------	---------------	---------------------	---------------------

Set the wake-up delay time and use it with H9-03.

H9-05	Pressure setting	Scope: 0.0~H9-06	Initial value: 3.0bar
-------	------------------	------------------	-----------------------

Set the pressure size, e. g. 3.0bar (kg force / square cm²), and start the drive, the water pipe pressure automatically constant at 3.0bar.

H9-06	Sensor range	Scope: 0.0~600.0bar	Initial value: 10.0bar
-------	--------------	---------------------	------------------------

Pressure sensor range, common range of 1MPa, unit of 10.0bar (kg force / square cm).

H9-07	Hibernian pressure deviation	Scope: 0.0~120.0bar	Initial value: 0.1bar
-------	------------------------------	---------------------	-----------------------

Dormancy pressure deviation, dormancy treatment begins when the feedback pressure exceeds the set pressure H9-05-H9-07.

HC group for both analog input and analog output correction

HC-00	AI1 measured voltage 1	Initial value	Factory correction
	Set the scope	0.500V~4.000V	
HC-01	AI1 shows the voltage of 1	Initial value	Factory correction
	Set the scope	0.500V~4.000V	
HC-02	AI1 measured voltage 2	Initial value	Factory correction
	Set the scope	6.000V~9.999V	
HC-03	AI1 shows the voltage of 2	Initial value	Factory correction
	Set the scope	6.000V~9.999V	
HC-04	AI2 measured voltage 1	Initial value	Factory correction
	Set the scope	0.500V~4.000V	

HC-05	AI2 shows the voltage of 1	Initial value	Factory correction
	Set the scope	0.500V~4.000V	
HC-06	AI2 measured voltage 2	Initial value	Factory correction
	Set the scope	6.000V~9.999V	
HC-07	AI2 shows the voltage of 2	Initial value	Factory correction
	Set the scope	-9.999V~10.000V	
HC-08	AI3 measured voltage 1	Initial value	Factory correction
	Set the scope	-9.999V~10.000V	
HC-09	AI3 shows the voltage of 1	Initial value	Factory correction
	Set the scope	-9.999V~10.000V	
HC-10	AI3 measured voltage 2	Initial value	Factory correction
	Set the scope	-9.999V~10.000V	
HC-11	AI3 shows the voltage of 2	Initial value	Factory correction
	Set the scope	-9.999V~10.000V	

This set of functional codes is used to correct the analog input AI 1 to AI 3 to eliminate the effect of zero bias and gain of the analog input port. The functional parameters have been corrected in the factory, and when Initial value is restored, they will return to the value after Factory correction. Correction is generally not required in the application site.

HC-12	H01 target voltage 1	Initial value	Factory correction
	Set the scope	0.500V~4.000V	
HC-13	H01 Measured voltage 1	Initial value	Factory correction
	Set the scope	0.500V~4.000V	
HC-14	H01 target voltage 2	Initial value	Factory correction
	Set the scope	6.000V~9.999V	
HC-15	H01 Measured voltage 2	Initial value	Factory correction
	Set the scope	6.000V~9.999V	
HC-16	H02 target voltage 1	Initial value	Factory correction
	Set the scope	0.500V~4.000V	
HC-17	H02 Measured voltage 1	Initial value	Factory correction
	Set the scope	0.500V~4.000V	
HC-18	H02 target voltage 2	Initial value	Factory correction
	Set the scope	6.000V~9.999V	
HC-19	H0 Measured voltage 2	Initial value	Factory correction
	Set the scope	6.000V~9.999V	

This set of functional codes is used to correct for the analog output AO. The functional parameters have been corrected in the factory, and when Initial value is restored, they will return to the value after Factory correction. Correction is generally not required in the application site.

The target voltage is the theoretical output voltage value of the driver. The measured voltage refers to the actual output voltage value measured through the multimeter and other instruments.

U0 group monitors the system

U0 parameter group is used to monitor the running status information of the drive. Customers can view it through the panel to facilitate field debugging, or read the parameter group value through communication for upper computer monitoring. Among them, U0-00~U0-31 are the operation and downtime monitoring parameters defined in P7-03 and P7-04.

See U0 group parameter table for specific parameter function code, parameter name and minimum unit.

FC	Designation	Unit
U0-00	Running frequency (Hz)	0.01Hz
U0-01	Set Frequency (Hz)	0.01Hz
U0-02	Busbar voltage (V)	0.1V
U0-03	Output voltage (V)	1V
U0-04	Output (A)	0.01A
U0-05	Output power (kW)	0.1kW
U0-06	Output torque (%)	0.1%
U0-07	DI input mode	1
U0-08	DO output state	1
U0-09	AI1 Voltage (V)	0.01V
U0-10	AI2 Voltage (V)	0.01V
U0-11	AI3 Voltage (V)	0.01V
U0-12	Count value	1
U0-13	Length value	1

U0-14	Load speed is shown	1
U0-15	PID setting	1
U0-16	PID feedback	1
U0-17	PLC stage	1
U0-18	PULSE Input pulse frequency (Hz)	0.01kHz
U0-19	Feedback speed (in 0.1Hz)	0.1Hz
U0-20	The remaining running time	0.1Min
U0-21	AI1 pre before voltage	0.001V
U0-22	AI2 pre before voltage	0.001V
U0-23	AI3 pre before voltage	0.001V
U0-24	Linear velocity	1m/Min
U0-25	Current power time	1Min
U0-26	Current run time	0.1Min
U0-27	PULSE input pulse frequency	1Hz
U0-28	Communication set point	0.01%
U0-29	Encoder feedback speed	0.01Hz
U0-30	Primary frequency X is shown	0.01Hz
U0-31	Auxiliary frequency Y is shown	0.01Hz
U0-32	View any memory address value	1
U0-33	Synchronizer rotor position	0.0°
U0-34	Motor temperature value	1 °C
U0-35	Target torque, (%)	0.1%
U0-36	The rotation position	1
U0-37	Power factor Angle	0.1
U0-38	ABZ position	0.0
U0-39	V / F separates the target voltage	1V
U0-40	V / F separates the output voltage	1V
U0-41	DI input status is visually displayed	1

U0-42	DO input status is visually displayed	1
U0-43	JOG functional status is visually displayed as shown in 1	1
U0-44	JOG functional status visually visually 2	1
U0-59	Set the frequency of (%)	0.01%
U0-60	Running frequency (%)	0.01%
U0-61	Drive State	1

Chapter 9 E M C

9.1 EMC guide

9.1.1 The influence of harmonics:

The high harmonic of the power supply can cause damage to the driver. Therefore, in some places where the power grid quality is relatively poor, it is recommended to install an AC input reactor.

9.1.2 Electromagnetic interference and installation precautions:

There are two kinds of electromagnetic interference, one is the interference of the electromagnetic noise from the surrounding environment to the driver, and the other kind of interference is the interference generated by the driver to the surrounding equipment.

Installation precautions:

- 1) The grounding wire of the driver and other electrical products shall be well grounded;
- 2) The power input and output lines and weak electrical signal lines (such as control lines) should not be arranged in parallel and vertically when conditions permit;
- 3) The output power line of the drive is recommended to use shielded cable, or steel pipe shielding power line, and the shielding layer should be reliably grounded. For the lead line of disturbed equipment, it is recommended to use twisted pair shielding control wire, and the shielding layer should be reliably grounded down;

9.1.3 The processing method of the peripheral electromagnetic equipment disturbing the drive:

The general cause of the electromagnetic effects on the drive is a large number of relays, contactors, or electromagnetic brakes installed near the drive. When the drive is disturbed and misaction, it is recommended to use the following methods:

- 1) A surge inhibitor is added to the interference-generating device;
- 2) Install a filter to the drive input;
- 3) The driver shall control the signal line and the shielding layer reliably.

9.1.4 Drive interference with the peripheral equipment:

The noise of this part is divided into two kinds: one is the driver radiation interference, while the other is the conduction interference of the driver. These two disturbances expose the peripheral electrical equipment to electromagnetic or electrostatic induction. In turn, the device misfunctions. For several interference situations that are not same as, refer to the following methods:

- 1) Instruments, receivers and sensors used for measurement, The general signal is

relatively weak, If close to the drive or in a same as control cabinet, Susendble to interference and mismovement, It is recommended to adopt the following methods: keep away from the interference sources as far as possible; Do not arrange the signal line parallel to the power line, especially do not tie it parallel together; Shielding lines for signal lines and power lines, And is well grounded; add ferrite magnetic ring to the output side of the driver (select suppression frequency within 30~1000MHzScope), And 2~3 turns in the same as direction, For the bad conditions, EMC output filter;

2) When the disturbed equipment and the driver use the same as one power supply, it will cause conduction interference. If the above method can not eliminate the interference, the EMC filter should be installed between the driver and the power supply;

9.1.5 Lease current and treatment:

There are two forms of leakage current when using the drive: the leakage current to the ground and the leakage current between the lines.

1) Factors affecting the floor drain current and their solutions:

There is a distributed capacitance between the wire and the earth, the larger the distributed capacitance, the greater the leakage current; effective Reduce the distance between drives and motors to reduce the distributed capacitance. The larger the carrier frequency, the greater the leakage current. The carrier frequency can be reduced to reduce the leakage current. However, reducing the carrier frequency will lead to an increase of motor noise. Please note that adding a reactor is also the effective method to solve the leakage current.

There is a distributed capacitance between the output wiring of the driver. If the current through the line contains high harmonics, it may cause resonance and leakage current. At this point, the thermal relay may be misoperated.

The solution is to reduce the carrier frequency or install an output reactor. When using the drive, it is recommended to install no thermal relay between the drive and the motor, and to use the electronic over-current protection function of the drive.

9.1.6 EMC input filter for power input:

 Note: When using the filter, strictly use the rated value; Since the filter belongs to Class I electrical appliance, the filter metal shell should be in good contact with the metal ground of the installation cabinet and require good conductive continuity, otherwise there will be a risk of electric shock and seriously affect the EMC effect;

2) Through EMC test, the filter ground must be connected to the driver PE terminal to the same as common ground, otherwise the EMC effect will be seriously affected.

Chapter 10 Maintenance and fault diagnosis

10.1 Daily maintenance and maintenance of the drive

10.1.1 Current maintenance

Due to the influence of environmental temperature, humidity, dust and vibration, the devices inside the drive will be aging, resulting in the potential failure of the drive or reducing the service life of the driver. Therefore, it is necessary to perform daily and regular maintenance and maintenance of the drives.

Daily check items:

- 1) Whether the abnormal sound changes occur during the motor operation
- 2) Whether the vibration is generated during the motor operation
- 3) Whether the drive installation environment has changed
- 4) Whether the drive cooling fan is working properly
- 5) Whether the drive

is overheated

Cleaning:

- 1) The drive shall be kept clean at all times.
- 2) Remove the surface area dust on the drive to prevent the dust from entering the drive interior. Especially for the metal dust.
- 3) Remove the oil from the drive cooling fan.

10.1.2 Regular check

Check items regularly:

- 1) Check the air duct, and clean it regularly
- 2) Check the screws for loosening
- 3) Check the drive for corrosion
- 4) Check the terminals for arc pulling marks
- 5) Main circuit insulation test

Reminder: When measuring the insulation resistance with the megohm meter (please DC 500V megohm meter), remove the main return route from the driver. Do not test the control loop insulation with an insulation resistance meter. No high pressure testing required (factory done).

10.1.3 Drive vulnerable parts replacement

The vulnerable parts of the drive mainly include cooling fan and electrolytic capacitor for filter, whose life is closely related to the service environment and maintenance status. The general lifetime time is:

Device name	Life time (in years)
electric fan	2~3 Years
electrolytic capacitor	4~5 Years

Please calculate the device life according to the specific usage situation

1: The cooling fan may be damaged because of bearing wear, blade aging. Identification standard: whether there are cracks in fan blades, and whether there is abnormal vibration sound when startup.

2: Filter electrolytic capacitor may be damaged reasons: poor quality of input power supply, high ambient temperature, frequent load hopping, electrolyte aging. Discrimination standard: whether there is liquid leakage, whether the safety valve has been protruding, the determination of electrostatic capacitor, the measurement of insulation resistance.

10.1.4 Storage of drives

After purchasing the drive, users must pay attention to the temporary storage and long-term storage of the following points: storage as far as possible according to the original packaging into the company's packaging box. Long storage will lead to the deterioration of electrolytic capacitor, must be guaranteed in 2 years Electric time is at least 5 hours, and the input voltage must be slowly raised to the rating with the voltage regulator.

10.2 Warranty instructions for the drive

The free warranty refers to the drive itself. In normal use, failure or damage, our company is responsible for 18 months of warranty (from the date of manufacturing, with the barcode on the fuselage shall prevail), more than 18 months will be charged a reasonable maintenance fee;

Within 18 months, a certain maintenance fee shall be charged for the following conditions: the machine damage caused by the user not according to the operation manual; the damage caused by fire, flood, and voltage abnormality; the damage caused when the drive is used for abnormal function; the relevant service fee shall be calculated according to the unified standard of the manufacturer (if there is a contract, the principle of contract first).

10.2.1 Fault alarm and countermeasures

If a failure occurs during the operation of the drive system, the driver will immediately protect the motor to stop the output, and the drive fault relay contact acts during the same as. The drive panel will display the fault code. The fault type and common solution corresponding to the fault code are detailed in the following below.

The list in the table is for reference only. Do not repair or modify without authorization. If the fault cannot be eliminated, please seek technical support from our company or the product agent.

- List of fault information

Fault name	Panel display	Troubleshooting	Troubleshooting countermeasures
Inverter unit protection	Err01	<ol style="list-style-type: none"> 1. Short circuit of the drive output circuit 2. The motor and drive wiring is too long 3. The internal wiring of the drive is loose 	<ol style="list-style-type: none"> 1. Troubleshoot the peripheral faults 2. Install an electric reactor or an output filter 3. Plug in all the connecting cables
Accelerate over current	Err02	<ol style="list-style-type: none"> 1. Ground or short circuit exists in the drive output circuit 2. The control mode is vector and no parameter identification is performed 3. The acceleration time is too short 	<ol style="list-style-type: none"> 1. Troubleshoot the peripheral faults 2. Determine the motor parameters 3. Increase the acceleration time
		<ol style="list-style-type: none"> 4. Manual torque lifting or V / F curve is not appropriate 5. Low voltage 6. Start the rotating motor 7. Sudden loading during the acceleration process 8. The drive selection is too small 	<ol style="list-style-type: none"> 4. Adjust the lifting torque or V / F curve 5. Turn the voltage to normal Scope 6. Select the speed tracking to start or wait until the motor stops 7. Cancel the spike load 8. Choose drives with larger power levels
Slow down over current	Err03	<ol style="list-style-type: none"> 1. Ground or short circuit exists in the drive output circuit 2. The control mode is vector and no parameter identification 3. The deceleration time is too short 4. The voltage is low 5. Sudden load during deceleration 6. No brake unit and brake resistance are installed 	<ol style="list-style-type: none"> 1. Exclude peripheral faults 2. Conduct the motor parameter identification 3. Increase deceleration time 4. Turn the voltage to normal Scope 5. Cancel the spike load 6. Install the brake unit and the resistance
Constant speed over current	Err04	<ol style="list-style-type: none"> 1. There is a ground or a short circuit in the drive output circuit 2. The control mode is vector and no parameter identification 3. The voltage is low 4. Whether there is an inrush load in the run 5. The drive selection is too small 	<ol style="list-style-type: none"> 1. Exclude peripheral faults 2. Conduct the motor parameter identification 3. Turn the voltage to normal Scope 4. Cancel the spike load 5. Choose drives with larger power levels
Accelerated overvoltage	Err05	<ol style="list-style-type: none"> 1. The input voltage is high 2. Store in the external force to drag the motor operation 3. The acceleration time is too short 4. No brake unit and brake resistance are installed 	<ol style="list-style-type: none"> 1. Turn the voltage to normal Scope 2. Remove additional power or add brake resistance 3. Increase acceleration time 4. Install the brake unit and the resistance

Slow down over voltage	Err06	<ol style="list-style-type: none"> 1、 The input voltage is high 2、 External force drags the motor during the deceleration process 3、 The deceleration time is too short 4、 No brake unit and brake resistance are installed 	<ol style="list-style-type: none"> 1、 Turn the voltage to normal Scope 2、 Remove additional power or add brake resistance 3、 Increase deceleration time 4、 Install the brake unit and the resistance
Constant speed overvoltage	Err07	<ol style="list-style-type: none"> 1、 The input voltage is high 2、 There is an external force dragging the motor during the operation 	<ol style="list-style-type: none"> 1、 Turn the voltage to normal Scope 2、 Remove additional power or add brake resistance
Control power failure	Err08	The input voltage is not in the Scope as specified in the specification	Adjust the voltage to the specification Scope
Underpressure failure	Err09	<ol style="list-style-type: none"> 1、 Instantaneous power failure 2、 The drive input voltage is not in the normal Scope 3、 Bus voltage is abnormal 4、 The rectification bridge and the buffer resistance are abnormal 5、 Exception of drive board 6、 Control plate anomaly 	<ol style="list-style-type: none"> 1、 Reset fault 2、 Adjust the voltage to the normal level Scope 3、 Seek technical support 4、 Seek technical support 5、 Seek technical support 6、 Seek technical support
Drive overload	Err10	<ol style="list-style-type: none"> 1、 Whether the load is too large or the motor blocked 2、 The drive selection is too small 	<ol style="list-style-type: none"> 1、 Reduce the load and check the motor and mechanical condition 2、 Choose drives with larger power levels
Motor overload	Err11	<ol style="list-style-type: none"> 1、 Whether the load is too large or the motor blocked 2、 The drive selection is too small 	<ol style="list-style-type: none"> 1、 Reduce the load and check the motor and mechanical condition 2、 Choose drives with larger power levels
Input the missing phase	Err12	<ol style="list-style-type: none"> 1、 Three-phase input power supply is abnormal 2、 Exception of drive board 3、 Lightning protection plate abnormal 4、 Abnormal main control board 	<ol style="list-style-type: none"> 1、 Check and exclude the problems existing in the peripheral lines 2、 Seek technical support 3、 Seek technical support 4、 Seek technical support
Output lack of phase	Err13	<ol style="list-style-type: none"> 1、 Drive-to motor leads are abnormal 2、 The driver three-phase output is unbalanced when the motor runs 3、 Exception of drive board 4、 Module anomaly 	<ol style="list-style-type: none"> 1、 Exclude peripheral faults 2、 Check whether the three-phase winding of the motor is correct and troubleshooting 3、 Seek technical support 4、 Seek technical support
The module overheating	Err14	<ol style="list-style-type: none"> 1、 The ambient temperature is too high 2、 The air duct is blocked 3、 Fan damage 4、 The module thermistor is damaged 5、 The inverter module is damaged 	<ol style="list-style-type: none"> 1、 Reduce ambient temperature 2、 Clean the air duct 3、 Change the fan 4、 Replace the thermistor 5、 Replace the inverter module
External equipment failure	Err15	<ol style="list-style-type: none"> 1、 Enter the signal of the external fault through the terminal DI 2、 Enter the signal of the external 	<ol style="list-style-type: none"> 1、 Reset the operation 2、 Reset the operation

		failure through the virtual IO	
Communication fault	Err16	<ol style="list-style-type: none"> 1、 The upper computer is not working properly 2、 The communication line is not normal 3、 Communication extension card P0-28 is not set correctly 3、 Communication parameter FD group was not set correctly 	<ol style="list-style-type: none"> 1、 Check the upper machine wiring 2、 Check the communication connection line 3、 Set the communication extension card type correctly 4、 Set the communication parameters correctly
Contactor failure	Err17	<ol style="list-style-type: none"> 1、 The drive plate and the power supply are abnormal 2、 The contactor is not normal 	<ol style="list-style-type: none"> 1、 Replace the drive board or the power board 2、 Replace the contactor
Current detection failure	Err18	<ol style="list-style-type: none"> 1、 Check for the Hall device anomalies 2、 Exception of drive board 	<ol style="list-style-type: none"> 1、 Replace Hall devices 2、 Replace the drive board
Motor tuning fault	Err19	<ol style="list-style-type: none"> 1、 Motor parameters are not set according to the nameplate 2、 Parameter identification process has timed out 	<ol style="list-style-type: none"> 1、 Set the motor parameters correctly according to the nameplate 2、 Check the drive to the motor leads
Code disk failure	Err20	<ol style="list-style-type: none"> 1、 Encoder model number does not match 2、 Encoder connection error 3、 The encoder is damaged 4、 PG card anomaly 	<ol style="list-style-type: none"> 1、 Set the encoder type correctly according to the actual situation 2、 Exclude line failure 3、 Replace the encoder 4、 Replace the PG card
EEPROM	Err21	<ol style="list-style-type: none"> 1、 EEPROM The chip damage 	<ol style="list-style-type: none"> 1、 Replace the main control board
Drive hardware failure	Err22	<ol style="list-style-type: none"> 1、 There is excessive pressure 2、 There is a flow 	<ol style="list-style-type: none"> 1、 Press the overvoltage fault handling 2、 Press the overcurrent fault handling
Short circuit to ground fault	Err23	<ol style="list-style-type: none"> 1、 Motor short circuit to ground 	<ol style="list-style-type: none"> 1、 Replace the cable or motors
The ated running time reaches fault	Err26	<ol style="list-style-type: none"> 1、 The cumulative running time has reached the set point 	<ol style="list-style-type: none"> 1、 Clear the record information by using the parameter initialization function
User-defined fault 1	Err27	<ol style="list-style-type: none"> 1、 Enter the user-defined fault through the terminal DI 2、 Enter a user-defined fault through the virtual IO 	<ol style="list-style-type: none"> 1、 Reset the operation 2、 Reset the operation
User-defined fault 2	Err28	<ol style="list-style-type: none"> 1、 Enter the user-defined fault through the terminal DI 2、 Enter a user-defined fault through the virtual IO 	<ol style="list-style-type: none"> 1、 Reset the operation 2、 Reset the operation

Accumulated power-on time reaches the fault	Err29	1、 The cumulative power-on time reaches the set value	1、 Clear the record information by using the parameter initialization function
The load failure	Err30	1、 The drive operating current is less than P9-64	1、 Confirm for load detachment or P9-64, F9- 65 Whether the parameter setting conforms to the actual operating conditions
Runtime PID, feedback	Err31	1、 PID feedback is less than the PA-26 setting value	1、 Check the PID feedback signal or set the PA-26 as an appropriate value
Wave-by-wave flow limit failure	Err40	1、 Whether the load is too large or the motor blocked 2、 The drive selection is too small	1、 Reduce the load and check the motor and mechanical condition 2、 Choose drives with larger power levels
Switching motor fault during operation	Err41	1、 Change the current motor selection via the terminals during the drive operation	1、 Change the motor after the driver stops
Excessive speed deviation and large fault	Err42	1、 Encoder parameter set is incorrect 2、 Parameter identification was not performed 3、 The detection parameters P9-69 and P9-70 are not set properly	1、 Set the encoder parameters correctly 2、 Conduct the motor parameter identification 3、 Set the detection parameters reasonably according to the actual situation
Motor overspeed fault	Err43	1、 Encoder parameter set is incorrect 2、 Parameter identification was not performed 3、 Detection parameters of motor overspeed P9-67 and P9-68 The setting is unreasonable	1、 Detect temperature sensor wiring 2、 Reduce the load frequency or take other heat dissipation measures to dissipate the motor
Motor overtemperature failure	Err45	1、 Temperature sensor wiring is loose 2、 The motor temperature is too high	1、 Check the temperature sensor wiring 2、 Reduce the load frequency or strengthen the heat dissipation
Initial location error	Err51	1、 Motor parameters are too much from actual	1、 Reconfirm whether the motor parameters are correct, and focus on whether the rated current is set too low

10.2 Common faults and their handling methods

The following failures may be encountered during drive use, please refer to the following methods for simple failure analysis:

Nub	Fault phenomenon	Possible cause	Ways of resolution
1	The upper power is not shown	Grid voltage is not low or too low; Switch power failure on the drive board; The rectifier bridge damage; Damaged drive buffer resistance; Control board and keyboard failure; The connection between the control board and the drive board and the keyboard is broken;	Check the input power supply; Check the bus bar voltage; Re-plug 8-core and 28-core wiring; Seek manufacturer service;
2	Power up displays "500"	Poor connection between the drive board and the connection of the control board; Correlated device damage on the control board; Motor or motor wire has a short circuit to the ground; Hall fault; Grid voltage is too low;	Re-plug 8-core and 28-core wiring; Seek manufacturer service;
3	Power on the display "Err 23" alarm	Motor or output line short circuit to the ground; A damaged drive;	Measure the insulation of the motor and the output line with a shake table; Seek manufacturer services;
4	The power driver is normal, displays "500" after operation and stops immediately	Damage or blocked fan rotation; Peripheral control terminal wiring has a short circuit;	Change the fan; To of external short circuit faults;
5	Err 14 (Module overheating) fault	The carrier frequency setting is too high. Damaged fan or blocked air duct. Internal device damage of drive (thermocouple or other)	Reduce the load frequency (P0-15). Replace the fan and clean up the air duct. Seek manufacturer services.
6	The motor does not rotate after the drive runs	Motor and motor wire; Error in setting of drive parameters (motor parameters); poor connection between drive board and control board; Drive board failure;	Reconfirm the connection between the drive and the motor; Replace the motor or remove the mechanical faults; check and reset the motor parameters;
7	DI digital input terminal has failed	Parameter setting error; External signal error; The OP and + 24V jumper lines are loose; Control board failure;	Check and reset the relevant parameters of F4 group; Reconnect the external signal lines; Re-confirm OP and + 24V jumper; Seek manufacturer service;

8	During the closed-loop vector control	Encoder failure; The encoder has the wrong line or poor contact; PG card fault; drive board failure;	Replace the code plate and reconfirm the wiring; replace the PG card; Seek services;
9	The drive frequently reports overcurrent and overvoltage faults.	Improper setting of motor parameters; Inappropriate acceleration and deceleration time; Load fluctuation;	Reset the motor parameters or perform the motor harmonious; Set the appropriate acceleration and deceleration time; seek the manufacturer's service;
10	Power up (or run) to Err 17	The soft start contactor is not engaged;	Check whether the contactor cable is loose; Check whether the contactor is faulty;
			Check for the contactor 24V power supply hitch; Seek manufacturer services;
11	On the electric display	Correlated device damage on the control board;	Replace the control board

Appendix Modbus communication agreement

This series of drives provides RS485 communication interface and supports Modbus-RTU slave communication protocol. Users can realize centralized control through the computer or PLC, set the drive running command through the communication protocol, modify or read the function code parameters, read the working state and fault information of the drive, etc.

1 Agreement content

The serial communication protocol defines the information content and usage format transmitted in the serial communication. This includes: host polling (or broadcast) format; host coding method, including: required action function code, transmission data and error check. The response of the slave also adopts the structure of phase same as, including: action confirmation, return data and error check, etc. If the slave has an error while receiving the information, or cannot complete the action required by the host, it will organize a failure information and feedback to the host in response.

1.1 Apply styles

The drive is connected to a "single-master and multi-slave" PC / PLC control network with RDI485 bus, as the communication slave.

1.2 Bus configuration

■ Hardware interface

Pluinsert RS485 expansion card EXT485 hardware on the drive

■ Topology structure

Single-host multi-slave system. Each communication device in the network has a unique slave address, in which one device is used as the communication host (often flat PC host, PLC, HMI, etc.), actively initiates communication to read or write the slave parameters, other devices are for communication slave, responding to the host inquiry or communication operation. Only one device can send data at time same as, while other devices are in the receiving state.

The Set the scope of the slave address is 1~247, and 0 is the broadcast communication address. The slave address in the network must be unique.

■ Communication Transmission mode

Asynchronous serial, semi-duplex transmission mode. In the process of serial asynchronous communication, data is sent one frame at a time in the form of a message. The MODBUS-RTU protocol stipulates that the idle time of no data on the communication

data line is greater than the transmission time of 3.5 Byte, so then the start of a new communication frame is expressed.

The built-in communication protocol of A810 series drive is Modbus-RTU slave communication protocol, which can respond to the "query / command" of the host, or make corresponding actions according to the "query / command" of the host, and communication data answer.

The host can refer to a personal computer (PC), industrial control equipment or programmable logic controller (PLC), etc. The host can not only communicate to a slave alone, but also release broadcast information to all the lower slave. For the separate access query / command of the host, the visited slave returns a reply frame; for the broadcast information, the host needs no feedback response to the host.

2 Communication Data structure

Communication Data Structure The Modbus protocol communication data format for this series of drives is as follows:

In RTU mode, message sending starts at a minimum of 3.5 characters. Diverse character time at the network wave rate, which is the easiest to achieve (as shown in T1-T2-T3-T4 below). The first domain to transport is the device address.

The transfer character that can be used is the 0.9,A.F in hex. The network device constantly detects the network bus, including during the pause interval. When the first domain (address domain) receives, each device decodes to determine whether it is sent to it. After the last transmission character, a pause of at least 3.5 character time calibrates the end of the message. A new message can start after this pause.

The entire message frame must be transmitted as a continuous stream. If there is a pause time of more than 1.5 characters before the frame completes, the receiving device will refresh the incomplete message and assume that the next byte is the address field for a new message.same as Site, if a new message is less than 3.5 characters before the previous message begins, the receiving device will regard it as a continuation of the previous message. This would lead to an error because the value in the last CRC domain could not be correct.

RTU frame format:

Frame-head START	A 3.5-character time
Deliver address ADR	Communication Address: 1~247
Command code CMD	03: Read the slave parameters; 06: Write the slave parameters
Data Content DATA (N-1)	
Data Content DATA (N-2)	

.....	Data content: functional code parameter address, number of functional code parameters, functional code parameter value, etc.
Data content, DATA 0	
CRC CHK High level	Test value: the CRC value.
CRC CHK Low level	
END	A 3.5-character time

CMD (command instruction) and DATA (data word description)

Command code: 03H, read N words (Word) (up to 12 words can be read) e. g., start address P002 of a slave address 01

Host command information

ADR	01H
CMD	03H
The opening address is high	P0H
The address of the beginning is low	02H
High number of registers	00H
Low number of registers	02H
CRC CHK Low level	Its CRC CHK-value remains to be calculated

CRC CHK High level	
--------------------	--

The slave response message Pd-05 is set to 0 time

ADR	01H
CMD	03H
High number of bytes	00H
Low number of bytes	04H
Data P002H high level	00H
Data P002H low	00H
Data P003H high level	00H
Data P003H high level	01H
CRC CHK Low level	Its CRC CHK-value remains to be calculated
CRC CHK High level	

Pd-05 was set to 1

ADR	01H
CMD	03H
Number of bytes	04H
Data P002H high level	00H

Data P002H low	00H
Data P003H high level	00H
Data at P003H low	01H
CRC CHK Low level	Its CRC CHK-value remains to be calculated
CRC CHK High level	

Command code: 06H Write a word (Word) such as: write 5000 (1388H) to the P00AH address of the slave address 02H drive.

Host command information

ADR	02H
CMD	06H
The information address is high	P0H
Information address low	0AH
The information content is high	13H
The information content is low	88H
CRC CHK Low level	The CRC CHK-value remains to be calculated
CRC CHK High level	

Responses information from the machine

ADR	02H
CMD	06H
The information address is high	P0H
Information address low	0AH
The information content is high	13H
The information content is low	88H
CRC CHK Low level	The CRC CHK-value remains to be calculated
CRC CHK High level	

Verification mode — CRC calibration mode: The CRC (Cyclical Redundancy Check) uses the RTU frame format, and the message includes the error detection domain based on the CRC method. The CRC domain detects the content of the entire message. The CRC domain is two bytes containing a binary value of 16 bits. It is calculated by the transmission device and then added to the message. The receiving device recalculates the CRC that has received the message and compares the value in the received CRC domain, and if the two CRC values are not equal, the transmission error occurs.

CRC is done by first saving 0xFFFF and then calling a process to process the continuous 8-bit bytes in the message with the value in the current register. Only the 8 Bit

data in each character is invalid for CRCeffective, start and stop bits, and parity bits.

During CRC generation, each 8-bit character is different from register content or (XOR), and the result is moved towards the lowest effective bit and the highest effective bit is filled with 0. The LSB was extracted for detection, not if LSB was 1, register alone and preset values were different, or if LSB is 0. The entire procedure was repeated 8 times. After the last digit (8th digit) is completed, the next 8-bit byte is separately different from the current value of the register. The value in the final register is the CRC value after all bytes in the message.

Example of the CRC calibration program

```
unsigned int crc_chk_value (unsigned char *data_value,unsigned char lengTA)
{
    unsigned int crc_value = 0xFFFF;
    int i;
    while (lengTA-->0)
    {
        crc_value ^= *data_value++;
        for (i=0;i<8;i++)
        {
            if (crc_value&0x0001) crc_value=
                (crc_value>>1) ^0xH001;
        }
    }
}
```

3 Communication address definition

Function code parameter section:

Take the group number and the parameter serial number combination of the current communication operation function code as the communication address:

High bytes: P 0 ~ PF (P), H 0 ~ HF (H), 70~7F (U group) Low bytes: 00~FF For example: P3-12, address is F30C; Note: PF group: Neither read nor change parameters; U group: Read only, and cannot change parameters.

Some parameters cannot be changed when the drive is running; some parameters cannot be changed regardless of the state of the drive; change the function code parameters, and pay attention to the Scope, unit, and related instructions of the parameters.

In addition, because EEPROM is frequently stored, it will reduce the service life of EEPROM, so some function codes in communication mode, do not need to store, just change the value in RAM.

If it is a group F parameter, to achieve this function, as long as the high F of the function code address into 0. If it is A group parameter, to achieve this function, as long as the high A of the function code address into 4. The corresponding function code address is as follows: high byte: 00~0F (group F), 40~4F (group A) low byte: 00~FF in compliance with: Function code P3-12 is not stored in EEPROM, the address is 030C; function code H0-05 is not stored in EEPROM, the address is 4005; the address indicates that can only write RAM, cannot read, read is invalid address. For all the parameters, this function can also be implemented using the command code 07H.

Stop / operation parameters section:

Parameter address	Parametric description
1000	* Communication Setpoint (-10000~10000) (decimal)
1001	running frequency
1002	busbar voltage
1003	output voltage
1004	output(current)
1005	output(current)
1006	output torque
1007	running speed
1008	DI Input Logo
1009	DO output sign
100A	AI1 voltage
100B	AI2 voltage
100C	AI3 voltage

100D	Count the numerical input
100E	Length value input
100F	loading speed
1010	PID set up
1011	PID feedback
1012	PLC step
1013	PULSE input pulse frequency at 0.01 kHz
1014	Feedback speed in 0.1Hz
1015	The remaining running time
1016	AI1 pre before voltage
1017	AI2 pre before voltage

Be careful:

The communication set point is the percentage of the relative value, 10000 corresponds to 100.00% and -10000 corresponds to -100.00%. For frequency dimension data, the percentage is the percentage of the relative maximum frequency (P0-10); for torque dimension data, the percentage is P2-10, H2-48 (set for the second motor torque).

Control command input to the drive: (write only)

Command word address	Command function
2000	0001: Is running
	0002: Reverse operation
	0003: Normal inching turning
	0004: Reverse inching turning
	0005: Free shutdown
	0006: deceleration stop
	0007: Fault is reset

Read the drive status: (read-only)

status word address	State word function
---------------------	---------------------

Parameter lock password check: (if 8888H, the password check passed)

Password address	Enter the contents of the password
1P00	*****

Command address	Command content
-----------------	-----------------

2001	BIT0: DO1outgoing control BIT1: DO2outgoing control BIT2: RELAY1outgoing control BIT3: RELAY2outgoing control BIT4: FMR outgoing control BIT5 : VDO1 BIT6: VDO2 BIT7 : VDO3 BIT8: VDO4 BIT9: VDO5
------	--

Analog output AO1 control: (write only)

Command address	Command content
2002	0~7FFFIndicate0%~100%

Analog output AO2 control: (write only)

Command address	Command content
2003	0~7FFFIndicate0%~100%

Pulse (PULSE) outgoing control: (write only)

Command address	Command content
2004	0~7FFF representation 0%~100%

Drive fault description:

Drive failure address	Drive failure information	
	0000: trouble-free	0015: Parameter read and write exception
	0001: Keep	0016: Drive hardware failure
	0002: Accelerate over current	0017: Motor short-circuit to the ground fault
	0003: Slow down over current	0018: Keep
	0004: Constant speed over current	0019: Keep
	0005: Accelerated overvoltage	001A: Running time arrives
	0006: Slow down over voltage	001B: User-defined fault 1

8000	0007: Constant speed overvoltage	001C: User-defined fault 2
	0008: Buffer resistance overload fault	001D: Power-on time arrives
	0009: Underpressure failure	001E: drop load
	000A: Drive overload	001F: The PID feedback is lost during the runtime
	000B: Motor overload	0028: Fast current limit timeout fault
	000D: Output lack of phase	002A: Speed deviation is too large
	000E: The module overheating	002B: Motor overspeed
8000	000F: External failure	002D: Motor over temperature
	0010: Communication unusual	005A: Number of encoder lines set correctly
	0011: Contactor anomaly	005B: Encoder is missed
	0012: Current detection failure	005C: Initial position is wrong
	0013: Motor tuning fault	005E: Speed feedback error
	0014: Encoder / PG, card fault	

Description of the communication parameters of the PD group

Pd-00	Baud rate	Initial value	6005
	Set the scope	the unit : MODUBS baud rate	
		0: 300BPS 1: 600BPS 2: 1200BPS 3: 2400BPS 4: 4800BPS	5: 9600BPS 6: 19200BPS 7: 38400BPS 8: 57600BPS 9: 115200BPS

This parameter is used to set the data transfer rate between the upper computer and the drive. Note that the baud rate set by the upper machine and the driver must be consistent, otherwise, the communication cannot proceed. The larger the port rate, the faster the communication speed.

Pd-01	Data format	Initial value	0
	Set the scope	0: No check: Data format <8, N, 2> 1: Initial test: Data format <8, E, 1> 2: Odd check: data format <8, O, 1> 3: No check: Data format <8-N-1>	

The data format set by the upper computer and the drive must be consistent, otherwise, the communication cannot proceed

Pd-02	This machine address	Initial value	1
	Set the scope	1~247,0 is for the broadcast address	

When the local address is set to 0, it is the broadcast address, realizing the broadcasting function of the upper computer.

The native address is unique (except the broadcast address), which is the basis of the point to point host and driver communication.

Pd-03	Response delay	Initial value	2ms
	Set the scope	0~20ms	

Response delay: the intermediate interval between the end of drive data acceptance and the data sent by the upper computer. If the response delay is less than the system processing time, the response delay shall be subject to the system processing time. If the response delay is longer than the system processing time, the system will process the data and delay until the response delay time to send the data to the upper machine

Pd-04	Communication Timeout time	Initial value	0.0 s
	Set the scope	0.0 s (invalid) ; 0.1~60.0s	

When this function code is set to 0.0s, the communication timeout time parameter invalid.

When the function code is set to the effective value, if the interval between one communication and the next communication exceeds the communication timeout time, the system will report the communication fault error (Err 16). Usually, it is set to invalid. In a continuous communication system, set the secondary parameter, you can monitor the communication status.

Pd-05	Communication Agreement selection	Initial value	31
	Set the scope	0: Non-standard Modbus protocol; 1: standard Modbus Agreement	

Pd-05=31: the Modbus protocol for the selection criteria.

Pd-05=30: When reading the command, the number of returned bytes is one byte more than the standard Modbus protocol, please see the "5 communication Data Structure" section of this protocol.

Pd-06	Communication Read the current resolution	Initial value	0
	Set the scope	0: 0.01A; 1: 0.1A	

Used to determine the output unit of the current value when the communication reads the output current.

Warranty agreement

1 The warranty period of this product is 18 months (subject to the information of fuselage bar code). During the warranty period, if the product breaks down or is damaged under normal use according to the instruction manual, our company is responsible for free maintenance.

2 During the warranty period, if the damage is caused by the following reasons, a certain maintenance fee will be charged:

- A. machine damage caused by errors in use and self-repair or modification without authorization;
- B. machine damage caused by fire, flood, abnormal voltage, other natural disasters and secondary disasters;
- C. hardware damage caused by man-made falling and transportation after purchase;
- D. machine damage caused by not operating in accordance with the user's manual provided by our company;
- E failures and damages caused by obstacles other than machines (e.g. external equipment factors);

3 In case of product failure or damage, please fill in the contents of Product Warranty Card correctly and in detail.

4. The collection of maintenance fees shall be subject to the maintenance price list newly adjusted by our company.

5 This warranty card will not be reissued under normal circumstances. Please keep this card and show it to maintenance personnel during warranty.

6. If there is any problem in the service process, please contact our agent or our company in time.

Edition: V2.1

Thanks for choosing HNC product.

Any technique support, please feel free to contact our support team

Tel: 86(20)84898493 Fax: 86(20)61082610

URL: www.hncelectric.com

Email: support@hncelectric.com

